

# Argent, a Precious, *Cloud.*

design Dodo Arslan  
terzani.com

**TERZANI**  
LA LUCE PENSATA



**Type |**  
Suspension

**Materials |**  
Stainless steel

**Finishes | Code**



-  Stainless Steel  
0N90S E7 C8
-  Gold plated  
0N90S L6 C8

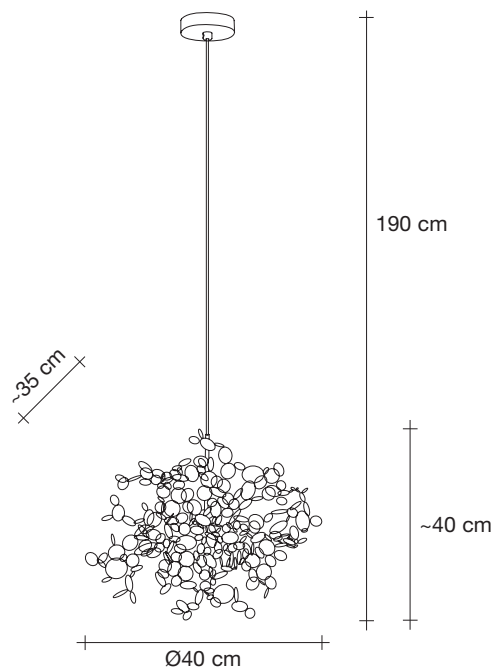

**Body |**



**Light Source |**

230-240V ~ 50/60Hz

-  HALOGEN  
3 x 20W G4 12V
-  Dimmable with IGBT  
Dali system on request
- **or on request**

---
-  LED  
3 x 2W G4 12V
-  Not Dimmable  
Dali system on request

**Canopy |**

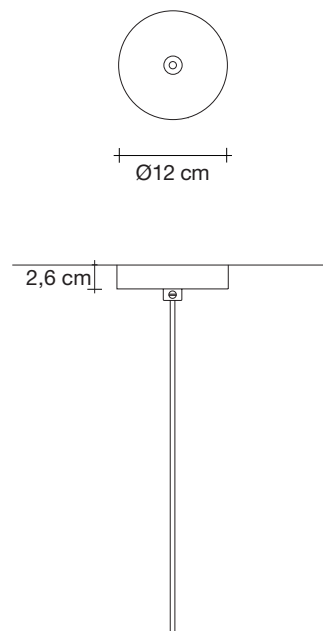

With this new suspension light, designer Dodo Arslan creates a shimmering, silver cloud. Argent consists of metal discs that have been meticulously joined by hand by Terzani craftsmen into clusters. Once lit, the multiple, angled surfaces of the discs emanate a soft, shimmering glow. Design Dodo Arslan.



5,4



2,5



51cm x 51cm x 51cm

# Argent, a Precious, *Cloud.*

design Dodo Arslan  
terzani.com

**TERZANI**  
LA LUCE PENSATA



**Type |**  
Suspension

**Materials |**  
Stainless steel

**Finishes | Code**

-  Stainless Steel  
0N91S E7 C8
-  Gold plated  
0N91S L6 C8



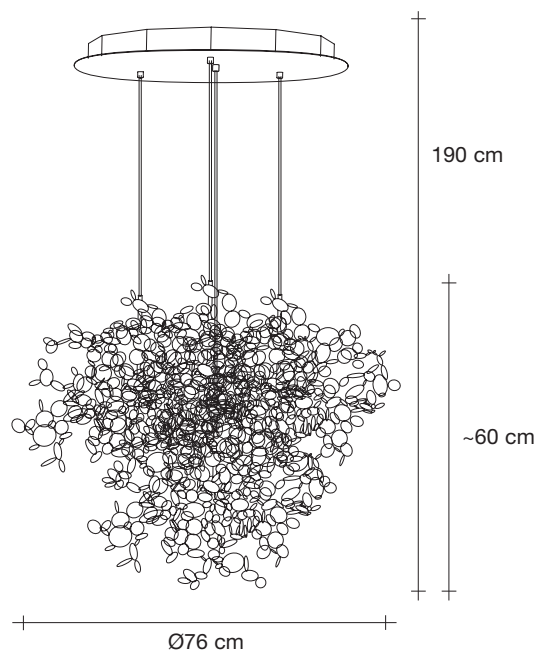

White canopy

Body |



**Light Source |**

230-240V ~ 50/60Hz

-  HALOGEN  
12 x 20W G4 12V
-  Dimmable with IGBT  
Dali system on request
- or on request**
-  LED  
12 x 2W G4 12V
-  Dimmable with IGBT  
Dali system on request

Canopy |

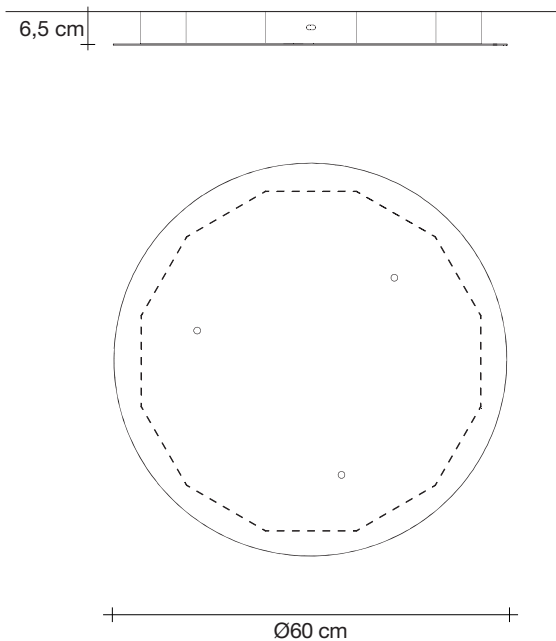

With this new suspension light, designer Dodo Arslan creates a shimmering, silver cloud. Argent consists of metal discs that have been meticulously joined by hand by Terzani craftsmen into clusters. Once lit, the multiple, angled surfaces of the discs emanate a soft, shimmering glow. Design Dodo Arslan.



32



18,5



115cm x 95cm x 75cm

# Argent, a Precious, *Cloud.*

design Dodo Arslan  
terzani.com

**TERZANI**  
LA LUCE PENSATA



**Type |**  
Suspension

**Materials |**  
Stainless steel

**Finishes | Code**

 Stainless Steel  
ON92S E7 C8

 Gold plated  
ON92S L6 C8

White canopy

**Body |**

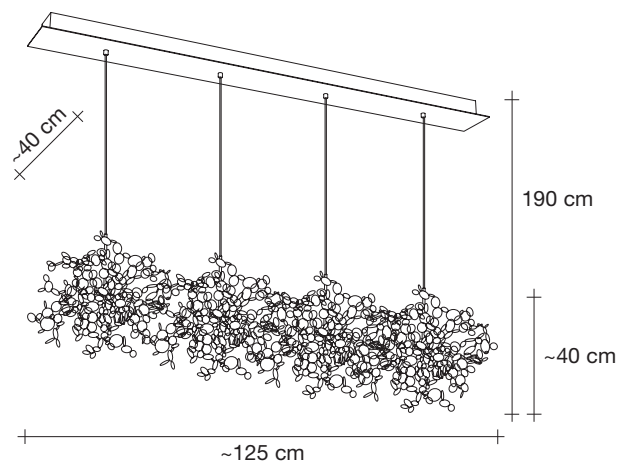

**Light Source |**

230-240V ~ 50/60Hz

 HALOGEN  
12 x 20W G4 12V

 Dimmable with IGBT  
Dali system on request

or on request

 LED  
12 x 2W G4 12V

 Dimmable with IGBT  
Dali system on request

**Canopy |**

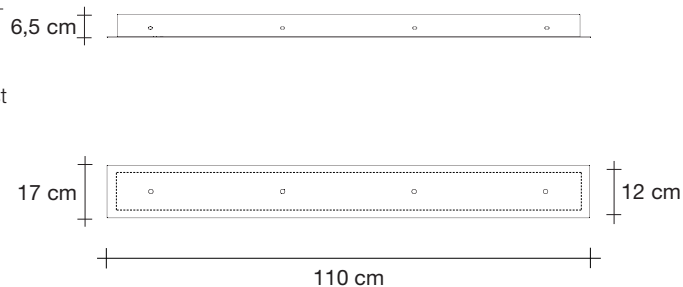

With this new suspension light, designer Dodo Arslan creates a shimmering, silver cloud. Argent consists of metal discs that have been meticulously joined by hand by Terzani craftsmen into clusters. Once lit, the multiple, angled surfaces of the discs emanate a soft, shimmering glow. Design Dodo Arslan.

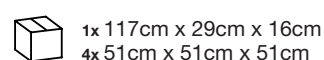

8

6,6

2,5



1x 117cm x 29cm x 16cm  
4x 51cm x 51cm x 51cm

# Argent, a Precious, *Cloud.*

design Dodo Arslan  
terzani.com

**TERZANI**  
LA LUCE PENSATA



**Type |**  
Suspension

**Materials |**  
Stainless steel



**Finishes | Code**

-  Stainless Steel  
ON93S E7 C8
-  Gold plated  
ON93S L6 C8

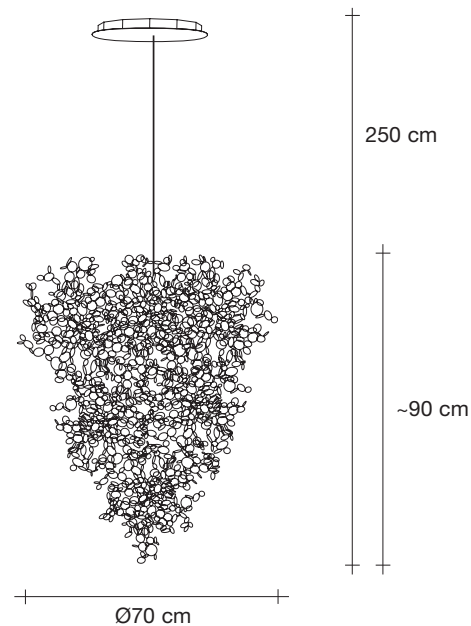
**Body |**



**Light Source |**  
230-240V ~ 50/60Hz

-  LED integrated  
12 x 2,1W  
3285 lm
-  Dimmable with 1-10V  
and Dali systems only

**Canopy |**

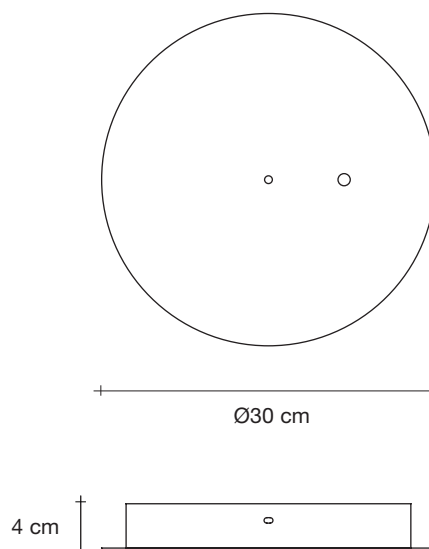

With this new suspension light, designer Dodo Arslan creates a shimmering, silver cloud. Argent consists of metal discs that have been meticulously joined by hand by Terzani craftsmen into clusters. Once lit, the multiple, angled surfaces of the discs emanate a soft, shimmering glow. Design Dodo Arslan.



60



22,5



80cm x 80cm x 180cm

# Argent, a Precious, *Cloud.*

design Dodo Arslan  
terzani.com

**TERZANI**  
LA LUCE PENSATA



**Type |**  
Suspension

**Materials |**  
Stainless steel



**Finishes | Code**

-  Stainless Steel  
ON94S E7 C8
-  Gold plated  
ON94S L6 C8

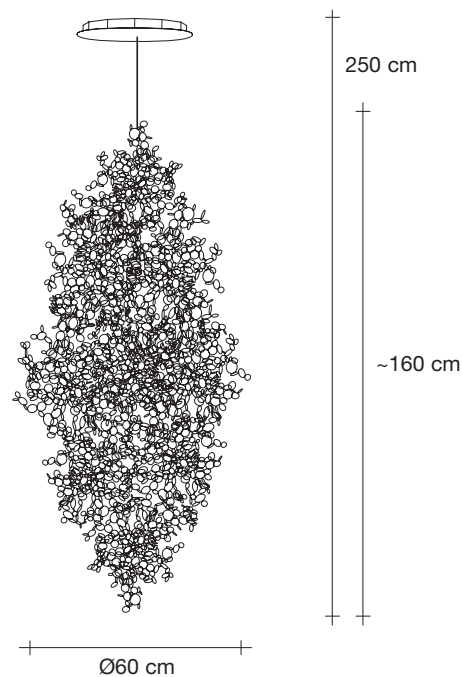
**Body |**



**Light Source |**  
230-240V ~ 50/60Hz

-  LED integrated  
18 x 2,1W  
4930 lm
-  Dimmable with 1-10V  
and Dali systems only

**Canopy |**

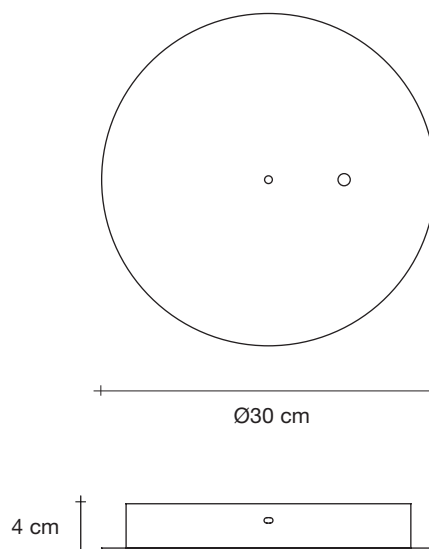

With this new suspension light, designer Dodo Arslan creates a shimmering, silver cloud. Argent consists of metal discs that have been meticulously joined by hand by Terzani craftsmen into clusters. Once lit, the multiple, angled surfaces of the discs emanate a soft, shimmering glow. Design Dodo Arslan.



70



36



80cm x 80cm x 180cm