

# TECHNICAL DATA SHEET

## INDOX 50 W IP54

BATHROOM - STANZA DA BAGNO - BADEZIMMER - BADKAMER - SALLE DE BAINS - CUARTO DE BAÑO

Fix (not adjustable) 0° - 0°

144x168 mm

Material : CALCYT® plaster

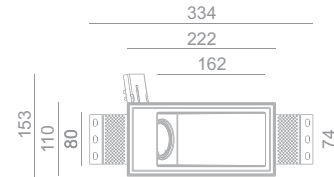
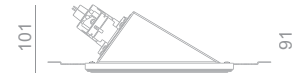
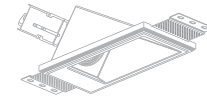
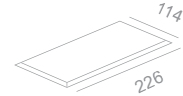

### INDOX 50 W LED WARMDIM

WARMDIM : DIMS FROM 3000°K TO 2000°K

REF N°	500LM CRI80	900LM CRI90
phase DIM	222 72 641	222 73 641
DIM 1-10V	222 62 641	222 63 641
DIM DALI	222 32 641	222 33 641

6W (500lm) - 12,8W (900lm) - 4 Step MacAdam  
 □ - 230V/50Hz - CE - ▽ - ⚡ - A  
 Incl. LED driver (phase DIM, 1-10V or DALI)  
 Standard beam angle 36° (options 24°)  
 h = 120 mm (500lm) - h = 155 mm (900lm)

### INDOX 50 W LED 1300LM CRI 80

REF N°	2700°K	3000°K	4000°K
phase DIM	222 73 041	222 73 141	222 73 241
DIM 1-10V	222 63 041	222 63 141	222 63 241
DIM DALI	222 33 041	222 33 141	222 33 241

Xicato LED - 11,7W - 1300lm - 2 Step MacAdam  
 □ - 230V/50Hz - CE - ▽ - ⚡ - A  
 Incl. LED driver (phase DIM, 1-10V or DALI)  
 Standard beam angle 36° (options 12°, 24°)  
 h = 155 mm

### INDOX 50 W LED 700LM CRI 80

REF N°	2700°K	3000°K	4000°K
phase DIM	222 72 041	222 72 141	222 72 241
DIM 1-10V	222 62 041	222 62 141	222 62 241
DIM DALI	222 32 041	222 32 141	222 32 241

Xicato LED - 5,6 W - 720lm - 2 Step MacAdam  
 □ - 230V/50Hz - CE - ▽ - ⚡ - A+  
 Incl. LED driver (phase DIM, 1-10V or DALI)  
 Standard beam angle 36° (options 12°, 24°)  
 h = 98 mm (phase DIM models beam 36°)  
 h = 120 mm (all other models)

### INDOX 50 W LED 700LM CRI 97

REF N°	2700°K	3000°K	4000°K
phase DIM	222 72 941	222 72 841	222 72 741
DIM 1-10V	222 62 941	222 62 841	222 62 741
DIM DALI	222 32 941	222 32 841	222 32 741

Xicato LED - 7,4 W - 720lm - 2 Step MacAdam  
 □ - 230V/50Hz - CE - ▽ - ⚡ - A  
 Incl. LED driver (phase DIM, 1-10V or DALI)  
 Standard beam angle 36° (options 12°, 24°)  
 h = 120 mm (models beam angle 36°)  
 h = 155 mm (models beam angle 12° or 24°)

### INDOX 50 W HAL

REF N° 222 10 051

⚡ QR-CBC 51 - 50W - Gx5.3 - 12V  
 ◊ - CE - ⚡ - ▽ - (0.5m) - D  
 h = 98 mm - exclusive lamp and transfo

### INDOX 50 W ES

REF N° 222 11 051

⚡ QPAR 16 - 50W - GZ10/GU10 - ⚡  
 ◊ - CE - 230V/50Hz - ▽ - (0.5m) - D  
 h = 100 mm - exclusive lamp

### INSTALLATION KIT

- STANDARD** (included) installation system for ceiling 9 - 12 - 15 mm
- REF N° 222 99 025** installation system for gypsum ceiling 25 mm
- REF N° 222 99 030** installation system for gypsum ceiling 30 mm

### BEAM ANGLES

- STANDARD** (included) beam angle 36°
- REF N° 205 50 012** optional beam angle 12°
- REF N° 205 50 024** optional beam angle 24°

### EMERGENCY UNITS

- REF N° 693 01 001** 1h basic + control LED
- REF N° 693 01 003** 3h basic + control LED
- REF N° 693 30 001** 1h EMPRO DALI
- REF N° 693 30 003** 3h EMPRO DALI



# TECHNICAL DATA SHEET

## INDOX 50 W IP54

OUTDOOR - ESTERNO - AUßENBEREICH - EXTERIEUR - EXTÉRIEUR - EXTERIOR

Fix (not adjustable) 0° - 0°

144x168 mm

Material : waterproof CALCYT+®

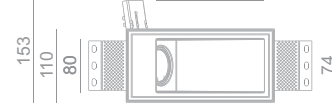
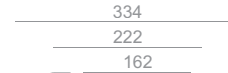
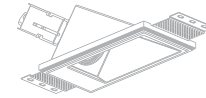
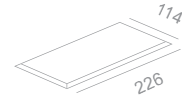

### INDOX 50 W LED WARMDIM

WARMDIM : DIMS FROM 3000°K TO 2000°K

REF N°	500LM CRI80	900LM CRI90
phase DIM	222 72 645	222 73 645
DIM 1-10V	222 62 645	222 63 645
DIM DALI	222 32 645	222 33 645

6W (500lm) - 12,8W (900lm) - 4 Step MacAdam  
 □ - 230V/50Hz - CE - ▽ - ⚡ - A  
 Incl. LED driver (phase DIM, 1-10V or DALI)  
 Standard beam angle 36° (options 24°)  
 h = 120 mm (500lm) - h = 155 mm (900lm)

### INDOX 50 W LED 1300LM CRI 80

REF N°	2700°K	3000°K	4000°K
phase DIM	222 73 045	222 73 145	222 73 245
DIM 1-10V	222 63 045	222 63 145	222 63 245
DIM DALI	222 33 045	222 33 145	222 33 245

Xicato LED - 11,7W - 1300lm - 2 Step MacAdam  
 □ - 230V/50Hz - CE - ▽ - ⚡ - A  
 Incl. LED driver (phase DIM, 1-10V or DALI)  
 Standard beam angle 36° (options 12°, 24°)  
 h = 155 mm

### INDOX 50 W LED 700LM CRI 80

REF N°	2700°K	3000°K	4000°K
phase DIM	222 72 045	222 72 145	222 72 245
DIM 1-10V	222 62 045	222 62 145	222 62 245
DIM DALI	222 32 045	222 32 145	222 32 245

Xicato LED - 5,6 W - 720lm - 2 Step MacAdam  
 □ - 230V/50Hz - CE - ▽ - ⚡ - A+  
 Incl. LED driver (phase DIM, 1-10V or DALI)  
 Standard beam angle 36° (options 12°, 24°)  
 h = 98 mm (phase DIM models beam 36°)  
 h = 120 mm (all other models)

### INDOX 50 W LED 700LM CRI 97

REF N°	2700°K	3000°K	4000°K
phase DIM	222 72 945	222 72 845	222 72 745
DIM 1-10V	222 62 945	222 62 845	222 62 745
DIM DALI	222 32 945	222 32 845	222 32 745

Xicato LED - 7,4 W - 720lm - 2 Step MacAdam  
 □ - 230V/50Hz - CE - ▽ - ⚡ - A  
 Incl. LED driver (phase DIM, 1-10V or DALI)  
 Standard beam angle 36° (options 12°, 24°)  
 h = 120 mm (models beam angle 36°)  
 h = 155 mm (models beam angle 12° or 24°)

### INDOX 50 W HAL

REF N° 222 10 055

⚡ QR-CBC 51 - 50W - Gx5.3 - 12V  
 ◊ - CE - ⚡ - ▽ - (0.5m) - D  
 h = 98 mm - exclusive lamp and transfo

### INDOX 50 W ES

REF N° 222 11 055

⚡ QPAR 16 - 50W - GZ10/GU10 - ⚡  
 ◊ - CE - 230V/50Hz - ▽ - (0.5m) - D  
 h = 100 mm - exclusive lamp

### INSTALLATION KIT

- STANDARD** (included) installation system for ceiling 9 - 12 - 15 mm
- REF N° 222 99 025** installation system for gypsum ceiling 25 mm
- REF N° 222 99 030** installation system for gypsum ceiling 30 mm

### BEAM ANGLES

- STANDARD** (included) beam angle 36°
- REF N° 205 50 012** optional beam angle 12°
- REF N° 205 50 024** optional beam angle 24°

### EMERGENCY UNITS

- REF N° 693 01 001** 1h basic + control LED
- REF N° 693 01 003** 3h basic + control LED
- REF N° 693 30 001** 1h EMPRO DALI
- REF N° 693 30 003** 3h EMPRO DALI

# TECHNICAL DATA SHEET

## INDOX 50 W IP20

INDOOR - INTERNO - INNENBEREICH - INTERIEUR - INTÉRIEUR - INTERIOR

Adjustable  $\varnothing$  0° - 30°

144x168 mm

Material : CALCYT® plaster

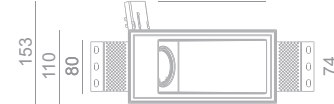
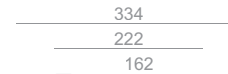
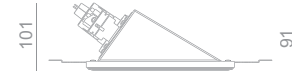
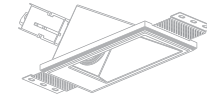
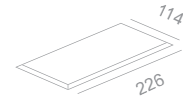

INDOX 50 W LED WARMDIM		
WARMDIM : DIMS FROM 3000°K TO 2000°K		
REF N°	500LM CRI80	900LM CRI90
phase DIM	222 72 640	222 73 640
DIM 1-10V	222 62 640	222 63 640
DIM DALI	222 32 640	222 33 640
6W (500lm) - 12,8W (900lm) - 4 Step MacAdam - 230V/50Hz -  -  -  - Incl. LED driver (phase DIM, 1-10V or DALI) Standard beam angle 36° (options 24°) h = 120 mm (500lm) - h = 155 mm (900lm)		

INDOX 50 W LED 1300LM CRI 80			
REF N°	2700°K	3000°K	4000°K
phase DIM	222 73 040	222 73 140	222 73 240
DIM 1-10V	222 63 040	222 63 140	222 63 240
DIM DALI	222 33 040	222 33 140	222 33 240
Xicato LED - 11,7W - 1300lm - 2 Step MacAdam - 230V/50Hz -  -  -  - Incl. LED driver (phase DIM, 1-10V or DALI) Standard beam angle 36° (options 12°, 24°) h = 155 mm			

INDOX 50 W LED 700LM CRI 80			
REF N°	2700°K	3000°K	4000°K
phase DIM	222 72 040	222 72 140	222 72 240
DIM 1-10V	222 62 040	222 62 140	222 62 240
DIM DALI	222 32 040	222 32 140	222 32 240
Xicato LED - 5,6 W - 720lm - 2 Step MacAdam - 230V/50Hz -  -  -  - Incl. LED driver (phase DIM, 1-10V or DALI) Standard beam angle 36° (options 12°, 24°) h = 98 mm (phase DIM models beam 36°) h = 120 mm (all other models)			

INDOX 50 W LED 700LM CRI 97			
REF N°	2700°K	3000°K	4000°K
phase DIM	222 72 940	222 72 840	222 72 740
DIM 1-10V	222 62 940	222 62 840	222 62 740
DIM DALI	222 32 940	222 32 840	222 32 740
Xicato LED - 7,4 W - 720lm - 2 Step MacAdam - 230V/50Hz -  -  -  - Incl. LED driver (phase DIM, 1-10V or DALI) Standard beam angle 36° (options 12°, 24°) h = 120 mm (models beam angle 36°) h = 155 mm (models beam angle 12° or 24°)			

INDOX 50 W HAL
REF N° 222 10 050
QR-CBC 51 - 50W - Gx5,3 - 12V -  -  -  -  -  - h = 98 mm - exclusive lamp and transfo

INDOX 50 W ES
REF N° 222 11 050
QPAR 16 - 50W - GZ10/GU10 - -  - 230V/50Hz -  -  -  - h = 100 mm - exclusive lamp

### INSTALLATION KIT

- STANDARD** (included) installation system for ceiling 9 - 12 - 15 mm
- REF N° 222 99 025** installation system for gypsum ceiling 25 mm
- REF N° 222 99 030** installation system for gypsum ceiling 30 mm

### BEAM ANGLES

- STANDARD** (included) beam angle 36°
- REF N° 205 50 012** optional beam angle 12°
- REF N° 205 50 024** optional beam angle 24°

### EMERGENCY UNITS

- REF N° 693 01 001** 1h basic + control LED
- REF N° 693 01 003** 3h basic + control LED
- REF N° 693 30 001** 1h EMPRO DALI
- REF N° 693 30 003** 3h EMPRO DALI



# INDOX 50 W IP20

ACCESSORIES - ACCESSORI - ZUBEHÖR - ACCESSOIRES - ACCESORIOS



**STANDARD** (included) LAMPHOLDER RING WHITE



**REF N° 201 10 002** LAMPHOLDER RING BLACK



**REF N° 201 11 001**  
EXTENSION S WHITE  
Ø 56 x 26 mm ⌀ 0° - 10°



**REF N° 201 12 001**  
EXTENSION M WHITE  
Ø 56 x 36 mm ⌀ 0° - 10°



**REF N° 201 13 001**  
EXTENSION L WHITE  
Ø 56 x 68 mm ⌀ 0° - 10°



**REF N° 201 11 002**  
EXTENSION S BLACK  
Ø 56 x 26 mm ⌀ 0° - 10°



**REF N° 201 12 002**  
EXTENSION M BLACK  
Ø 56 x 36 mm ⌀ 0° - 10°



**REF N° 201 13 002**  
EXTENSION L BLACK  
Ø 56 x 68 mm ⌀ 0° - 10°



**REF N° 201 51 001**  
FROSTED PLEXI WHITE  
Only for LED lampsources



**REF N° 201 52 001**  
HONEYCOMB WHITE  
Only for LED lampsources



**REF N° 201 53 001**  
SPHERICAL GLASS LENS  
IN WHITE RING



**REF N° 201 51 002**  
FROSTED PLEXI BLACK  
Only for LED lampsources



**REF N° 201 52 002**  
HONEYCOMB BLACK  
Only for LED lampsources



**REF N° 201 53 002**  
SPHERICAL GLASS LENS  
IN BLACK RING

# TECHNICAL DATA SHEET

## INDOX 50 IP54

BATHROOM - STANZA DA BAGNO - BADEZIMMER - BADKAMER - SALLE DE BAINS - CUARTO DE BAÑO

Fix (not adjustable) 0° - 0°

144x168 mm

Material : CALCYT® plaster

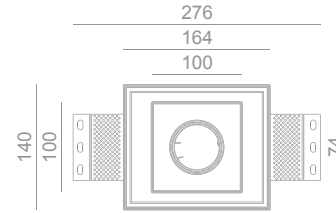
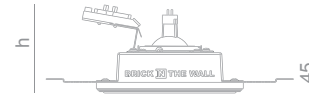
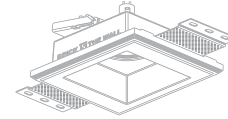

### INSTALLATION KIT

- STANDARD** (included) installation system for ceiling 9 - 12 - 15 mm
- REF N° 230 99 025** installation system for gypsum ceiling 25 mm
- REF N° 230 99 030** installation system for gypsum ceiling 30 mm
- REF N° 834 00 000** Concrete box InDOX 50 - Galvanized steel

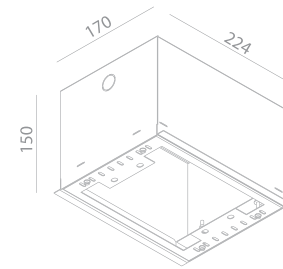

### BEAM ANGLES

- STANDARD** (included) beam angle 36°
- REF N° 205 50 012** optional beam angle 12°
- REF N° 205 50 024** optional beam angle 24°

### EMERGENCY UNITS

- REF N° 693 01 001** 1h basic + control LED
- REF N° 693 01 003** 3h basic + control LED
- REF N° 693 30 001** 1h EMPRO DALI
- REF N° 693 30 003** 3h EMPRO DALI

### INDOX 50 LED WARMDIM

WARMDIM : DIMS FROM 3000°K TO 2000°K

REF N°	500LM CRI80	900LM CRI90
phase DIM	230 72 641	230 73 641
DIM 1-10V	230 62 641	230 63 641
DIM DALI	230 32 641	230 33 641

Xicato LED - 12,8W (900lm) - 4 Step MacAdam  
 □ - 230V/50Hz - - - -   
 Incl. LED driver (phase DIM, 1-10V or DALI)  
 Standard beam angle 36° (options 24°)  
 h = 120 mm (500lm) - h = 155 mm (900lm)

### INDOX 50 LED 1300LM CRI 80

REF N°	2700°K	3000°K	4000°K
phase DIM	230 73 041	230 73 141	230 73 241
DIM 1-10V	230 63 041	230 63 141	230 63 241
DIM DALI	230 33 041	230 33 141	230 33 241

Xicato LED - 11,7W - 1300lm - 2 Step MacAdam  
 □ - 230V/50Hz - - - -   
 Incl. LED driver (phase DIM, 1-10V or DALI)  
 Standard beam angle 36° (options 12°, 24°)  
 h = 155 mm

### INDOX 50 LED 700LM CRI 80

REF N°	2700°K	3000°K	4000°K
phase DIM	230 72 041	230 72 141	230 72 241
DIM 1-10V	230 62 041	230 62 141	230 62 241
DIM DALI	230 32 041	230 32 141	230 32 241

Xicato LED - 5,6 W - 720lm - 2 Step MacAdam  
 □ - 230V/50Hz - - - -   
 Incl. LED driver (phase DIM, 1-10V or DALI)  
 Standard beam angle 36° (options 12°, 24°)  
 h = 98 mm (phase DIM models beam 36°)  
 h = 120 mm (all other models)

### INDOX 50 LED 700LM CRI 97

REF N°	2700°K	3000°K	4000°K
phase DIM	230 72 941	230 72 841	230 72 741
DIM 1-10V	230 62 941	230 62 841	230 62 741
DIM DALI	230 32 941	230 32 841	230 32 741

Xicato LED - 7,4 W - 720lm - 2 Step MacAdam  
 □ - 230V/50Hz - - - -   
 Incl. LED driver (phase DIM, 1-10V or DALI)  
 Standard beam angle 36° (options 12°, 24°)  
 h = 120 mm (models beam angle 36°)  
 h = 155 mm (models beam angle 12° or 24°)

### INDOX 50 HAL

REF N° 230 10 051

QR-CBC 51 - 50W - Gx5.3 - 12V  
 - - - - -   
 h = 98 mm - exclusive lamp and transfo

### INDOX 50 ES

REF N° 230 11 051

QPAR 16 - 50W - GZ10/GU10 -   
 - - 230V/50Hz - - -   
 h = 100 mm - exclusive lamp



# TECHNICAL DATA SHEET

## INDOX 50 IP54

OUTDOOR - ESTERNO - AUßENBEREICH - EXTERIEUR - EXTERIOR

Fix (not adjustable) 0° - 0°

144x168 mm

Material : waterproof CALCYT+®

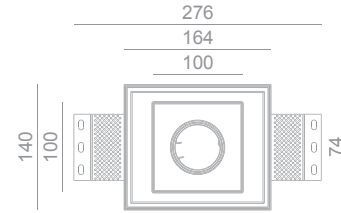
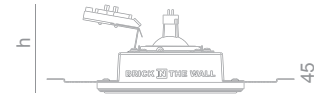
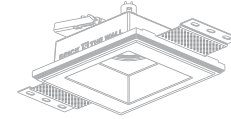

### INSTALLATION KIT

- STANDARD** (included) installation system for ceiling 9 - 12 - 15 mm
- REF N° 230 99 025** installation system for gypsum ceiling 25 mm
- REF N° 230 99 030** installation system for gypsum ceiling 30 mm
- REF N° 834 00 000** Concrete box InDOX 50 - Galvanized steel

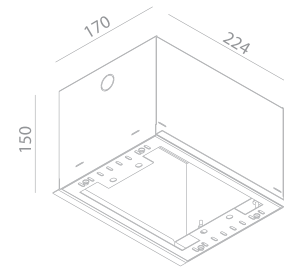

### BEAM ANGLES

- STANDARD** (included) beam angle 36°
- REF N° 205 50 012** optional beam angle 12°
- REF N° 205 50 024** optional beam angle 24°

### EMERGENCY UNITS

- REF N° 693 01 001** 1h basic + control LED
- REF N° 693 01 003** 3h basic + control LED
- REF N° 693 30 001** 1h EMPRO DALI
- REF N° 693 30 003** 3h EMPRO DALI

### INDOX 50 LED WARMDIM

WARMDIM : DIMS FROM 3000°K TO 2000°K

REF N°	500LM CRI80	900LM CRI90
phase DIM	230 72 645	230 73 645
DIM 1-10V	230 62 645	230 63 645
DIM DALI	230 32 645	230 33 645

6W (500lm) - 12,8W (900lm) - 4 Step MacAdam  
 ☐ - 230V/50Hz - - - -   
 Incl. LED driver (phase DIM, 1-10V or DALI)  
 Standard beam angle 36° (options 24°)  
 h = 120 mm (500lm) - h = 155 mm (900lm)

### INDOX 50 LED 1300LM CRI 80

REF N°	2700°K	3000°K	4000°K
phase DIM	230 73 045	230 73 145	230 73 245
DIM 1-10V	230 63 045	230 63 145	230 63 245
DIM DALI	230 33 045	230 33 145	230 33 245

Xicato LED - 11,7W - 1300lm - 2 Step MacAdam  
 ☐ - 230V/50Hz - - - -   
 Incl. LED driver (phase DIM, 1-10V or DALI)  
 Standard beam angle 36° (options 12°, 24°)  
 h = 155 mm

### INDOX 50 LED 700LM CRI 80

REF N°	2700°K	3000°K	4000°K
phase DIM	230 72 045	230 72 145	230 72 245
DIM 1-10V	230 62 045	230 62 145	230 62 245
DIM DALI	230 32 045	230 32 145	230 32 245

Xicato LED - 5,6 W - 720lm - 2 Step MacAdam  
 ☐ - 230V/50Hz - - - -   
 Incl. LED driver (phase DIM, 1-10V or DALI)  
 Standard beam angle 36° (options 12°, 24°)  
 h = 98 mm (phase DIM models beam 36°)  
 h = 120 mm (all other models)

### INDOX 50 LED 700LM CRI 97

REF N°	2700°K	3000°K	4000°K
phase DIM	230 72 945	230 72 845	230 72 745
DIM 1-10V	230 62 945	230 62 845	230 62 745
DIM DALI	230 32 945	230 32 845	230 32 745

Xicato LED - 7,4 W - 720lm - 2 Step MacAdam  
 ☐ - 230V/50Hz - - - -   
 Incl. LED driver (phase DIM, 1-10V or DALI)  
 Standard beam angle 36° (options 12°, 24°)  
 h = 120 mm (models beam angle 36°)  
 h = 155 mm (models beam angle 12° or 24°)

### INDOX 50 HAL

REF N° 230 10 055

QR-CBC 51 - 50W - Gx5.3 - 12V  
 - - - - -   
 h = 98 mm - exclusive lamp and transfo

### INDOX 50 ES

REF N° 230 11 055

QPAR 16 - 50W - GZ10/GU10 -   
 - - 230V/50Hz - - -   
 h = 100 mm - exclusive lamp

# TECHNICAL DATA SHEET

## INDOX 50 IP20

INDOOR - INTERNO - INNENBEREICH - INTERIEUR - INTÉRIEUR - INTERIOR

Adjustable  $\odot$  0° - 30°

□ 144x168 mm

Material : CALCYT® plaster

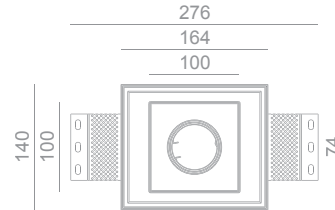
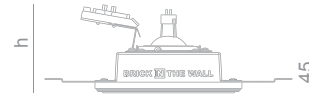
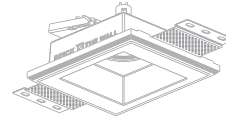

### INSTALLATION KIT

- STANDARD** (included) installation system for ceiling 9 - 12 - 15 mm
- REF N° 230 99 025** installation system for gypsum ceiling 25 mm
- REF N° 230 99 030** installation system for gypsum ceiling 30 mm
- REF N° 834 00 000** Concrete box InDOX 50 - Galvanized steel

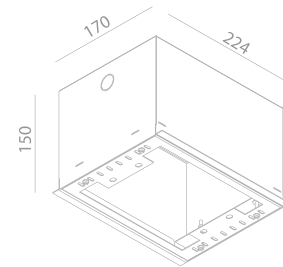

### BEAM ANGLES

- STANDARD** (included) beam angle 36°
- REF N° 205 50 012** optional beam angle 12°
- REF N° 205 50 024** optional beam angle 24°

### EMERGENCY UNITS

- REF N° 693 01 001** 1h basic + control LED
- REF N° 693 01 003** 3h basic + control LED
- REF N° 693 30 001** 1h EMPRO DALI
- REF N° 693 30 003** 3h EMPRO DALI

### INDOX 50 LED WARMDIM

WARMDIM : DIMS FROM 3000°K TO 2000°K

REF N°	500LM CRI80	900LM CRI90
phase DIM	230 72 640	230 73 640
DIM 1-10V	230 62 640	230 63 640
DIM DALI	230 32 640	230 33 640

6W (500lm) - 12,8W (900lm) - 4 Step MacAdam  
 □ - 230V/50Hz - **CE** -  $\nabla$  -  $\square$  - **B**  
 Incl. LED driver (phase DIM, 1-10V or DALI)  
 Standard beam angle 36° (options 24°)  
 h = 120 mm (500lm) - h = 155 mm (900lm)

### INDOX 50 LED 1300LM CRI 80

REF N°	2700°K	3000°K	4000°K
phase DIM	230 73 040	230 73 140	230 73 240
DIM 1-10V	230 63 040	230 63 140	230 63 240
DIM DALI	230 33 040	230 33 140	230 33 240

Xicato LED - 11,7W - 1300lm - 2 Step MacAdam  
 □ - 230V/50Hz - **CE** -  $\nabla$  -  $\square$  - **A**  
 Incl. LED driver (phase DIM, 1-10V or DALI)  
 Standard beam angle 36° (options 12°, 24°)  
 h = 155 mm

### INDOX 50 LED 700LM CRI 80

REF N°	2700°K	3000°K	4000°K
phase DIM	230 72 040	230 72 140	230 72 240
DIM 1-10V	230 62 040	230 62 140	230 62 240
DIM DALI	230 32 040	230 32 140	230 32 240

Xicato LED - 5,6 W - 720lm - 2 Step MacAdam  
 □ - 230V/50Hz - **CE** -  $\nabla$  -  $\square$  - **A+**  
 Incl. LED driver (phase DIM, 1-10V or DALI)  
 Standard beam angle 36° (options 12°, 24°)  
 h = 98 mm (phase DIM models beam 36°)  
 h = 120 mm (all other models)

### INDOX 50 LED 700LM CRI 97

REF N°	2700°K	3000°K	4000°K
phase DIM	230 72 940	230 72 840	230 72 740
DIM 1-10V	230 62 940	230 62 840	230 62 740
DIM DALI	230 32 940	230 32 840	230 32 740

Xicato LED - 7,4 W - 720lm - 2 Step MacAdam  
 □ - 230V/50Hz - **CE** -  $\nabla$  -  $\square$  - **A**  
 Incl. LED driver (phase DIM, 1-10V or DALI)  
 Standard beam angle 36° (options 12°, 24°)  
 h = 120 mm (models beam angle 36°)  
 h = 155 mm (models beam angle 12° or 24°)

### INDOX 50 HAL

REF N° 230 10 050

⚡ QR-CBC 51 - 50W - Gx5.3 - 12V  
 ◊ - **CE** -  $\square$  -  $\nabla$  -  $\square$  - 0.5m - **D**  
 h = 98 mm - exclusive lamp and transfo

### INDOX 50 ES

REF N° 230 11 050

⚡ QPAR 16 - 50W - GZ10/GU10 -  $\square$   
 ◊ - **CE** - 230V/50Hz -  $\nabla$  -  $\square$  - 0.5m - **D**  
 h = 100 mm - exclusive lamp

# INDOX 50 IP20

ACCESSORIES - ACCESSORI - ZUBEHÖR - ACCESSOIRES - ACCESSOIRES - ACCESORIOS



**STANDARD** (included) LAMPHOLDER RING WHITE



**REF N° 201 10 002** LAMPHOLDER RING BLACK



**REF N° 201 11 001**  
EXTENSION S WHITE  
Ø 56 x 26 mm  $\odot$  0° - 10°



**REF N° 201 12 001**  
EXTENSION M WHITE  
Ø 56 x 36 mm  $\odot$  0° - 10°



**REF N° 201 13 001**  
EXTENSION L WHITE  
Ø 56 x 68 mm  $\odot$  0° - 10°



**REF N° 201 11 002**  
EXTENSION S BLACK  
Ø 56 x 26 mm  $\odot$  0° - 10°



**REF N° 201 12 002**  
EXTENSION M BLACK  
Ø 56 x 36 mm  $\odot$  0° - 10°



**REF N° 201 13 002**  
EXTENSION L BLACK  
Ø 56 x 68 mm  $\odot$  0° - 10°



**REF N° 201 51 001**  
FROSTED PLEXI WHITE  
Only for LED lampsources



**REF N° 201 52 001**  
HONEYCOMB WHITE  
Only for LED lampsources



**REF N° 201 53 001**  
SPHERICAL GLASS LENS  
IN WHITE RING



**REF N° 201 51 002**  
FROSTED PLEXI BLACK  
Only for LED lampsources



**REF N° 201 52 002**  
HONEYCOMB BLACK  
Only for LED lampsources



**REF N° 201 53 002**  
SPHERICAL GLASS LENS  
IN BLACK RING



# TECHNICAL DATA SHEET

## INDOX R 50 IP54

BATHROOM - STANZA DA BAGNO - BADEZIMMER - BADKAMER - SALLE DE BAINS - CUARTO DE BAÑO

Fix (not adjustable) 0° - 0°

☐ Ø120 mm

Material : CALCYT® plaster

### INDOX R 50 LED 500LM CRI 80 REMOTE DRIVER WARMDIM

WARMDIM : DIMS FROM 3000°K TO 2000°K

REF N° 271 29 641

6 W - 500lm - 4 Step MacAdam

☑ - ☒ - ☒ - ☒ - ☒ - Excl. LED driver

Requires remote LED driver @ 350 mA

Standard beam angle 36° (options 24°)

h = 123 mm

### INDOX R 50 LED 700LM CRI 80 REMOTE DRIVER

REF N° 271 29 041 2700K

REF N° 271 29 141 3000K

REF N° 271 29 241 4000K

Xicato LED - 5,6W - 720lm - 2 Step MacAdam

☑ - ☒ - ☒ - ☒ - ☒ - Excl. LED driver

Requires remote LED driver @ 350 mA

Standard beam angle 36° (options 12°, 24°)

h = 123 mm

### INDOX R 50 HAL

REF N° 271 10 051

☑ QR-CBC 51 - 50W - Gx5.3 - 12V

☑ - ☑ - ☑ - ☑ - ☑ - ☑ - ☑ - ☑ - ☑

h = 123 mm - exclusive lamp and transfo

### INDOX R 50 ES

REF N° 271 11 051

☑ QPAR 16 - 50W - GZ10/GU10 - ☒

☑ - ☑ - 230V/50Hz - ☑ - ☑ - ☑ - ☑ - ☑

h = 123 mm - exclusive lamp

### REMOTE LED DRIVER ON/OFF

REF N° 697 00 006 8W

REF N° 697 00 015 15W

REF N° 697 00 025 25W

230V/50Hz - ☑ - current controlled

☑ - ☑ - IP20 - 350mA - not dimmable

### REMOTE LED DRIVER DIM

REF N° 697 60 006 6W 1-10V

REF N° 697 60 015 15W 1-10V

REF N° 697 30 015 15W DALI

REF N° 697 60 025 25W 1-10V DALI PUSH

REF N° 697 60 040 40W 1-10V DALI PUSH

REF N° 697 60 150 150W 1-10V

REF N° 697 30 150 150W DALI

REF N° 697 70 009 9W PHASE DIM (tr. edge)

REF N° 697 70 017 17W PHASE DIM

230V/50Hz - ☑ - current controlled

☑ - ☑ - IP20 - 350mA - dimmable

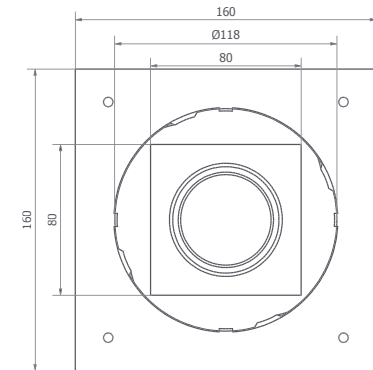
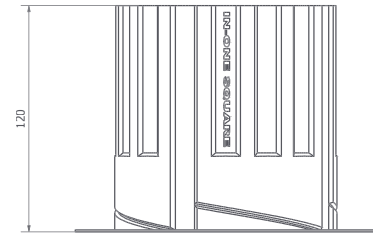
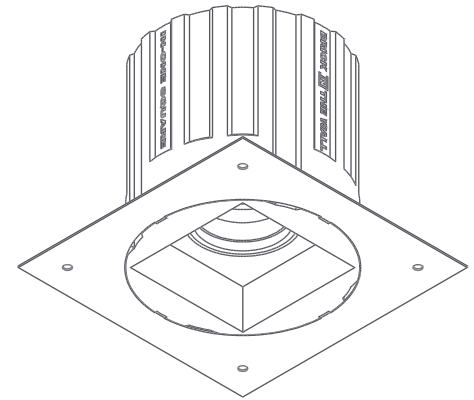

### INSTALLATION KIT

**STANDARD** (included) installation system for concrete ceiling  
height adjustable

### BEAM ANGLES

**STANDARD** (included) beam angle 36°

REF N° 205 50 012 optional beam angle 12°

REF N° 205 50 024 optional beam angle 24°

# TECHNICAL DATA SHEET

## INDOX R 50 IP54

OUTDOOR - ESTERNO - AUßENBEREICH - EXTERIEUR - EXTÉRIEUR - EXTERIOR

Fix (not adjustable) 0° - 0°

□ Ø120 mm

Material : waterproof CALCYT+®

### INDOX R 50 LED 500LM CRI 80 REMOTE DRIVER WARMDIM

WARMDIM : DIMS FROM 3000°K TO 2000°K

REF N° 271 29 645

6W - 500lm - 4 Step MacAdam

☑ - ▽ - ⚡ - ⚡ - Excl. LED driver

Requires remote LED driver @ 350 mA

Standard beam angle 36° (options 24°)

h = 123 mm

### INDOX R 50 LED 700LM CRI 80 REMOTE DRIVER

REF N° 271 29 045 2700K

REF N° 271 29 145 3000K

REF N° 271 29 245 4000K

Xicato LED - 5,6W - 720lm - 2 Step MacAdam

☑ - ▽ - ⚡ - ⚡ - Excl. LED driver

Requires remote LED driver @ 350 mA

Standard beam angle 36° (options 12°, 24°)

h = 123 mm

### INDOX R 50 HAL

REF N° 271 10 055

☑ QR-CBC 51 - 50W - Gx5.3 - 12V

☑ - ☑ - ⚡ - ▽ - ⚡ - 0.5m - ☑

h = 123 mm - exclusive lamp and transfo

### INDOX R 50 ES

REF N° 271 11 055

☑ QPAR 16 - 50W - GZ10/GU10 - ⚡

☑ - ☑ - 230V/50Hz - ▽ - ⚡ - 0.5m - ☑

h = 123 mm - exclusive lamp

### REMOTE LED DRIVER ON/OFF

REF N° 697 00 006 8W

REF N° 697 00 015 15W

REF N° 697 00 025 25W

230V/50Hz - ☑ - current controlled

▽ - ☑ - IP20 - 350mA - not dimmable

### REMOTE LED DRIVER DIM

REF N° 697 60 006 6W 1-10V

REF N° 697 60 015 15W 1-10V

REF N° 697 30 015 15W DALI

REF N° 697 60 025 25W 1-10V DALI PUSH

REF N° 697 60 040 40W 1-10V DALI PUSH

REF N° 697 60 150 150W 1-10V

REF N° 697 30 150 150W DALI

REF N° 697 70 009 9W PHASE DIM (tr. edge)

REF N° 697 70 017 17W PHASE DIM

230V/50Hz - ☑ - current controlled

▽ - ☑ - IP20 - 350mA - dimmable

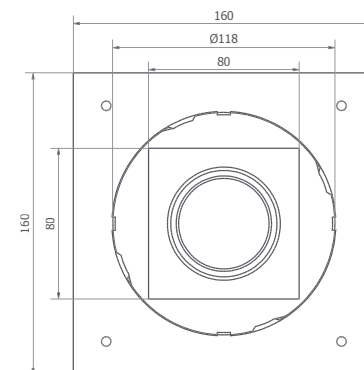
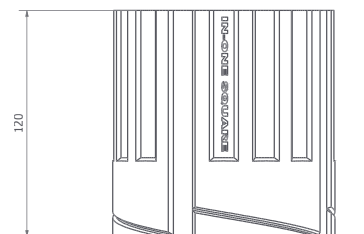
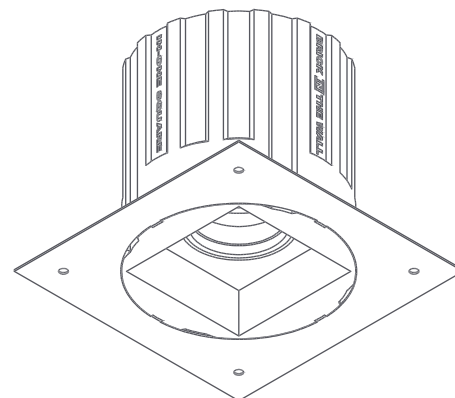

### INSTALLATION KIT

**STANDARD** (included) installation system for concrete ceiling  
height adjustable

### BEAM ANGLES

**STANDARD** (included) beam angle 36°

REF N° 205 50 012 optional beam angle 12°

REF N° 205 50 024 optional beam angle 24°

# TECHNICAL DATA SHEET

## INDOX R 50 IP20

INDOOR - INTERNO - INNENBEREICH - INTERIEUR - INTÉRIEUR - INTERIOR

Adjustable  $\odot$  0° - 30°

$\square$  Ø120 mm

Material : CALCYT® plaster

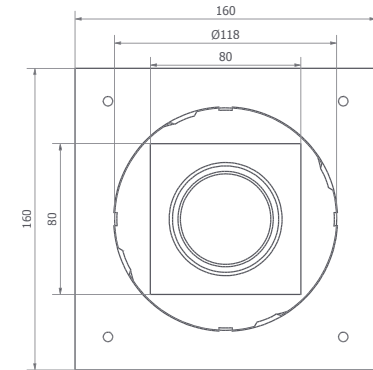
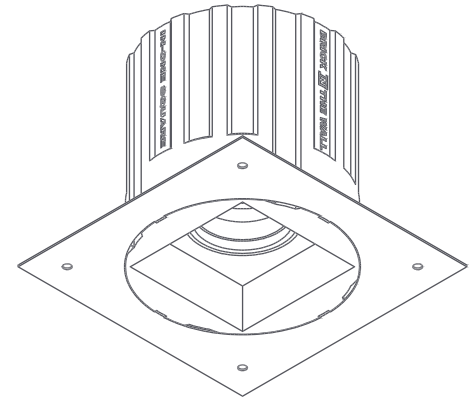

<b>INDOX R 50 LED 500LM CRI 80 REMOTE DRIVER WARMDIM</b>
<b>WARMDIM : DIMS FROM 3000°K TO 2000°K</b>
<b>REF N° 271 29 640</b>
6W - 500lm - 4 Step MacAdam CE - $\nabla$ - $\square$ - $\square$ - $\square$ - Excl. LED driver Requires remote LED driver @ 350 mA Standard beam angle 36° (options 24°) h = 123 mm

<b>INDOX R 50 LED 700LM CRI 80 REMOTE DRIVER</b>
<b>REF N° 271 29 040</b> 2700K
<b>REF N° 271 29 140</b> 3000K
<b>REF N° 271 29 240</b> 4000K
Xicato LED - 5,6W - 720lm - 2 Step MacAdam CE - $\nabla$ - $\square$ - $\square$ - $\square$ - Excl. LED driver Requires remote LED driver @ 350 mA Standard beam angle 36° (options 12°, 24°) h = 123 mm

<b>INDOX R 50 HAL</b>
<b>REF N° 271 10 050</b>
$\square$ QR-CBC 51 - 50W - Gx5.3 - 12V $\square$ - CE - $\square$ - $\square$ - $\square$ - $\square$ - $\square$ - $\square$ - $\square$ h = 123 mm - exclusive lamp and transfo

<b>REMOTE LED DRIVER ON/OFF</b>
<b>REF N° 697 00 006</b> 8W
<b>REF N° 697 00 015</b> 15W
<b>REF N° 697 00 025</b> 25W
230V/50Hz - $\square$ - current controlled $\nabla$ - CE - IP20 - 350mA - not dimmable

<b>REMOTE LED DRIVER DIM</b>
<b>REF N° 697 60 006</b> 6W 1-10V
<b>REF N° 697 60 015</b> 15W 1-10V
<b>REF N° 697 30 015</b> 15W DALI
<b>REF N° 697 60 025</b> 25W 1-10V DALI PUSH
<b>REF N° 697 60 040</b> 40W 1-10V DALI PUSH
<b>REF N° 697 60 150</b> 150W 1-10V
<b>REF N° 697 30 150</b> 150W DALI
<b>REF N° 697 70 009</b> 9W PHASE DIM (tr. edge)
<b>REF N° 697 70 017</b> 17W PHASE DIM
230V/50Hz - $\square$ - current controlled $\nabla$ - CE - IP20 - 350mA - dimmable

<b>INDOX R 50 ES</b>
<b>REF N° 271 11 050</b>
$\square$ QPAR 16 - 50W - GZ10/GU10 - $\square$ $\square$ - CE - 230V/50Hz - $\nabla$ - $\square$ - $\square$ - $\square$ - $\square$ h = 123 mm - exclusive lamp

### INSTALLATION KIT

**STANDARD** (included) installation system for concrete ceiling  
height adjustable

### BEAM ANGLES

**STANDARD** (included) beam angle 36°  
**REF N° 205 50 012** optional beam angle 12°  
**REF N° 205 50 024** optional beam angle 24°

# TECHNICAL DATA SHEET

## INDOX 30 IP54

BATHROOM - STANZA DA BAGNO - BADEZIMMER - BADKAMER - SALLE DE BAINS - CUARTO DE BAÑO

Adjustable  $\odot$  0° - 10°

$\square$  114x134 mm

Material : CALCYT® plaster

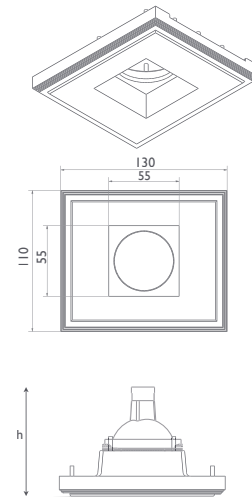

### INSTALLATION KIT

**STANDARD** (included) installation system for ceiling 9 - 12 - 15 mm

**REF N° 274 99 025** installation system for gypsum ceiling 25 mm

**REF N° 274 99 030** installation system for gypsum ceiling 30 mm

**REF N° 843 00 000** Concrete box Indox 30/50 - Galvanized steel

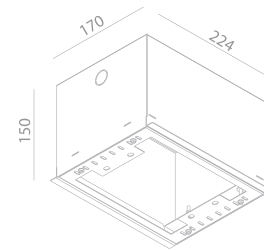

### BEAM ANGLES

**STANDARD** (included) beam angle 32°

**REF N° 204 30 024** optional beam angle 24°

**REF N° 204 30 040** optional beam angle 40°

**REF N° 204 30 050** optional beam angle 50°

### REMOTE LED DRIVER DIM

**250mA/350mA**

**REF N° 697 60 040** DIM 1-10V DALI PUSH 30W

**REF N° 697 60 150** DIM 1-10V 100W

**REF N° 697 30 150** DIM DALI 100W

#### INDOX 30 LED 450LM CRI 97 230VAC

**REF N° 274 71 931** phase DIM CRI 97 2700°K

**REF N° 274 71 831** phase DIM CRI 97 3000°K

6,5W - 450lm - 2 Step MacAdam  $\square$  230V/50Hz  
Standard beam angle 32° (options 40°, 50°)  
Parallel wiring - Connects directly to 230VAC  
h=98 -  $\square$  -  $\text{CE}$  -  $\nabla$  -  $\text{IA}$  -  $\text{P}$

#### INDOX 30 LED 450LM CRI 97 REMOTE DRIVER

**REF N° 274 29 931** excl. LED driver CRI 97 2700°K

**REF N° 274 29 831** excl. LED driver CRI 97 3000°K

6,5W - 450lm - 2 Step MacAdam  
Standard beam angle 32° (options 40°, 50°)  
Serial wiring - Requires remote LED driver  
h=98 -  $\square$  -  $\text{CE}$  -  $\nabla$  -  $\text{IA}$  -  $\text{P}$

#### INDOX 30 LED 600LM 230VAC

**REF N° 274 71 531** phase DIM CRI 80 2200°K

**REF N° 274 71 031** phase DIM CRI 90 2700°K

**REF N° 274 71 131** phase DIM CRI 90 3000°K

6,5W - 600lm - 2 Step MacAdam  $\square$  230V/50Hz  
Standard beam angle 32° (options 24°, 40°, 50°)  
Parallel wiring - Connects directly to 230VAC  
h=98 -  $\square$  -  $\text{CE}$  -  $\nabla$  -  $\text{IA}$  -  $\text{P}$

#### INDOX 30 LED 600LM REMOTE DRIVER

**REF N° 274 29 531** excl. LED driver CRI 80 2200°K

**REF N° 274 29 031** excl. LED driver CRI 90 2700°K

**REF N° 274 29 131** excl. LED driver CRI 90 3000°K

6,5W - 600lm - 2 Step MacAdam  
Standard beam angle 32° (options 24°, 40°, 50°)  
Serial wiring - Requires remote LED driver  
h=98 -  $\square$  -  $\text{CE}$  -  $\nabla$  -  $\text{IA}$  -  $\text{P}$



## INDOX 30 IP54

OUTDOOR - ESTERNO - AUßENBEREICH - EXTERIEUR - EXTERIOR

Adjustable  $\odot$  0° - 10°

$\square$  114x134 mm

Material : waterproof CALCYT+®

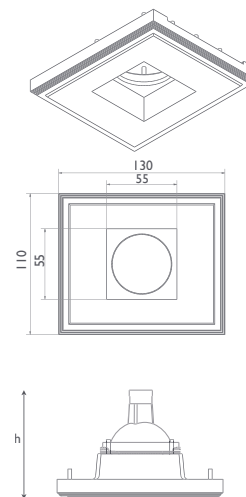

### INSTALLATION KIT

**STANDARD** (included) installation system for ceiling 9 - 12 - 15 mm

**REF N° 274 99 025** installation system for gypsum ceiling 25 mm

**REF N° 274 99 030** installation system for gypsum ceiling 30 mm

**REF N° 843 00 000** Concrete box Indox 30/50 - Galvanized steel

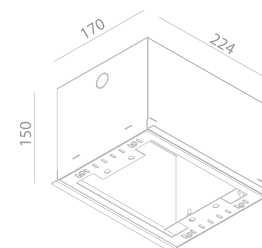

### BEAM ANGLES

**STANDARD** (included) beam angle 32°

**REF N° 204 30 024** optional beam angle 24°

**REF N° 204 30 040** optional beam angle 40°

**REF N° 204 30 050** optional beam angle 50°

### REMOTE LED DRIVER DIM

**250mA/350mA**

**REF N° 697 60 040** DIM 1-10V DALI PUSH 30W

**REF N° 697 60 150** DIM 1-10V 100W

**REF N° 697 30 150** DIM DALI 100W

#### INDOX 30 LED 450LM CRI 97 230VAC

**REF N° 274 71 935** phase DIM CRI 97 2700°K

**REF N° 274 71 835** phase DIM CRI 97 3000°K

6,5W - 450lm - 2 Step MacAdam  $\square$  230V/50Hz  
Standard beam angle 32° (options 40°, 50°)  
Parallel wiring - Connects directly to 230VAC  
h=98 -  $\square$  -  $\text{CE}$  -  $\nabla$  -  $\text{IA}$  -  $\text{P}$

#### INDOX 30 LED 450LM CRI 97 REMOTE DRIVER

**REF N° 274 29 935** excl. LED driver CRI 97 2700°K

**REF N° 274 29 835** excl. LED driver CRI 97 3000°K

6,5W - 450lm - 2 Step MacAdam  
Standard beam angle 32° (options 40°, 50°)  
Serial wiring - Requires remote LED driver  
h=98 -  $\square$  -  $\text{CE}$  -  $\nabla$  -  $\text{IA}$  -  $\text{P}$

#### INDOX 30 LED 600LM 230VAC

**REF N° 274 71 535** phase DIM CRI 80 2200°K

**REF N° 274 71 035** phase DIM CRI 90 2700°K

**REF N° 274 71 135** phase DIM CRI 90 3000°K

6,5W - 600lm - 2 Step MacAdam  $\square$  230V/50Hz  
Standard beam angle 32° (options 24°, 40°, 50°)  
Parallel wiring - Connects directly to 230VAC  
h=98 -  $\square$  -  $\text{CE}$  -  $\nabla$  -  $\text{IA}$  -  $\text{P}$

#### INDOX 30 LED 600LM REMOTE DRIVER

**REF N° 274 29 535** excl. LED driver CRI 80 2200°K

**REF N° 274 29 035** excl. LED driver CRI 90 2700°K

**REF N° 274 29 135** excl. LED driver CRI 90 3000°K

6,5W - 600lm - 2 Step MacAdam  
Standard beam angle 32° (options 24°, 40°, 50°)  
Serial wiring - Requires remote LED driver  
h=98 -  $\square$  -  $\text{CE}$  -  $\nabla$  -  $\text{IA}$  -  $\text{P}$



# TECHNICAL DATA SHEET

## INDOX 30 IP20

INDOOR - INTERNO - INNENBEREICH - INTERIEUR - INTÉRIEUR - INTERIOR

Adjustable  $\odot$  0° - 10°

114x134 mm

Material : CALCYT® plaster

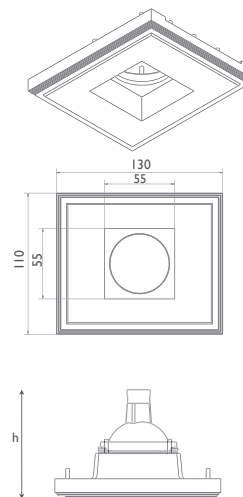

<b>INDOX 30 LED 450LM CRI 97 230VAC</b>
<b>REF N° 274 71 930</b> phase DIM CRI 97 2700°K
<b>REF N° 274 71 830</b> phase DIM CRI 97 3000°K
6,5W - 450lm - 2 Step MacAdam $\square$ 230V/50Hz Standard beam angle 32° (options 40°, 50°) Parallel wiring - Connects directly to 230VAC h=98 - $\text{CE}$ - $\nabla$ - $\text{A}$ - $\text{P}$

<b>INDOX 30 LED 450LM CRI 97 REMOTE DRIVER</b>
<b>REF N° 274 29 930</b> excl. LED driver CRI 97 2700°K
<b>REF N° 274 29 830</b> excl. LED driver CRI 97 3000°K
6,5W - 450lm - 2 Step MacAdam Standard beam angle 32° (options 40°, 50°) Serial wiring - Requires remote LED driver h=98 - $\text{CE}$ - $\nabla$ - $\text{A}$ - $\text{P}$

### INSTALLATION KIT

- STANDARD** (included) installation system for ceiling 9 - 12 - 15 mm  
**REF N° 274 99 025** installation system for gypsum ceiling 25 mm  
**REF N° 274 99 030** installation system for gypsum ceiling 30 mm  
**REF N° 843 00 000** Concrete box Indox 30/50 - Galvanized steel

<b>INDOX 30 LED 600LM 230VAC</b>
<b>REF N° 274 71 530</b> phase DIM CRI 80 2200°K
<b>REF N° 274 71 030</b> phase DIM CRI 90 2700°K
<b>REF N° 274 71 130</b> phase DIM CRI 90 3000°K
6,5W - 600lm - 2 Step MacAdam $\square$ 230V/50Hz Standard beam angle 32° (options 24°, 40°, 50°) Parallel wiring - Connects directly to 230VAC h=98 - $\text{CE}$ - $\nabla$ - $\text{A}$ - $\text{P}$

<b>INDOX 30 LED 600LM REMOTE DRIVER</b>
<b>REF N° 274 29 530</b> excl. LED driver CRI 80 2200°K
<b>REF N° 274 29 030</b> excl. LED driver CRI 90 2700°K
<b>REF N° 274 29 130</b> excl. LED driver CRI 90 3000°K
6,5W - 600lm - 2 Step MacAdam Standard beam angle 32° (options 24°, 40°, 50°) Serial wiring - Requires remote LED driver h=98 - $\text{CE}$ - $\nabla$ - $\text{A}$ - $\text{P}$

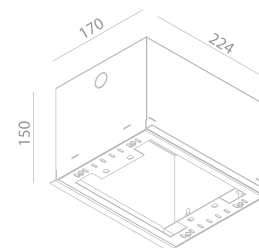

### BEAM ANGLES

- STANDARD** (included) beam angle 32°  
**REF N° 204 30 024** optional beam angle 24°  
**REF N° 204 30 040** optional beam angle 40°  
**REF N° 204 30 050** optional beam angle 50°

<b>INDOX 30 LED 200LM REAL SPOT 230VAC</b>
<b>REF N° 274 70 510</b> phase DIM CRI 80 2200°K
<b>REF N° 274 70 010</b> phase DIM CRI 90 2700°K
<b>REF N° 274 70 110</b> phase DIM CRI 90 3000°K
3W - 200lm - 3 Step MacAdam $\square$ 230V/50Hz 5° beam angle - $\text{CE}$ - $\nabla$ - $\text{A}$ - $\text{P}$ Parallel wiring - Connects directly to 230VAC h=98

<b>INDOX 30 LED 200LM REAL SPOT REMOTE DRIVER</b>
<b>REF N° 274 29 510</b> excl. LED driver CRI 80 2200°K
<b>REF N° 274 29 010</b> excl. LED driver CRI 90 2700°K
<b>REF N° 274 29 110</b> excl. LED driver CRI 90 3000°K
3W - 200lm - 3 Step MacAdam 5° beam angle - $\text{CE}$ - $\nabla$ - $\text{A}$ - $\text{P}$ Serial wiring - Requires remote LED driver h=98

### REMOTE LED DRIVER DIM 250mA/350mA

- REF N° 697 60 040** DIM 1-10V DALI PUSH 30W  
**REF N° 697 60 150** DIM 1-10V 100W  
**REF N° 697 30 150** DIM DALI 100W



# TECHNICAL DATA SHEET

## INDOX 50 MINI IP54

BATHROOM - STANZA DA BAGNO - BADEZIMMER - BADKAMER - SALLE DE BAINS - CUARTO DE BAÑO

Fix (not adjustable) 0° - 0°

114x144 mm

Material : CALCYT® plaster

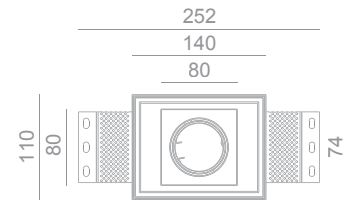
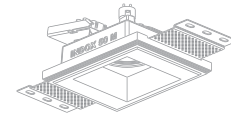

### INSTALLATION KIT

- STANDARD** (included) installation system for ceiling 9 - 12 - 15 mm
- REF N° 221 99 025** installation system for gypsum ceiling 25 mm
- REF N° 221 99 030** installation system for gypsum ceiling 30 mm
- REF N° 834 00 000** Concrete box Indox 50 mini - Galvanized steel

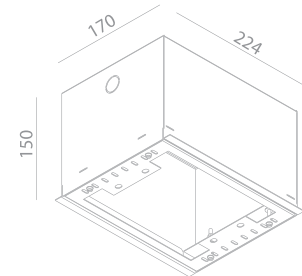

### BEAM ANGLES

- STANDARD** (included) beam angle 36°
- REF N° 205 50 012** optional beam angle 12°
- REF N° 205 50 024** optional beam angle 24°

### EMERGENCY UNITS

- REF N° 693 01 001** 1h basic + control LED
- REF N° 693 01 003** 3h basic + control LED
- REF N° 693 30 001** 1h EMPRO DALI
- REF N° 693 30 003** 3h EMPRO DALI

### INDOX 50 MINI LED WARM DIM

WARM DIM : DIMS FROM 3000°K TO 2000°K

REF N°	500LM CRI80	900LM CRI90
phase DIM	221 72 641	221 73 641
DIM 1-10V	221 62 641	221 63 641
DIM DALI	221 32 641	221 33 641

6W (500lm) - 12,8W (900lm) - 4 Step MacAdam  
 ☐ - 230V/50Hz - CE - ▽ - ⚡ - B  
 Incl. LED driver (phase DIM, 1-10V or DALI)  
 Standard beam angle 36° (options 24°)  
 h = 115 mm (500lm) - h = 150 mm (900lm)

### INDOX 50 MINI LED 1300LM CRI 80

REF N°	2700°K	3000°K	4000°K
phase DIM	221 73 041	221 73 141	221 73 241
DIM 1-10V	221 63 041	221 63 141	221 63 241
DIM DALI	221 33 041	221 33 141	221 33 241

Xicato LED - 11,7W - 1300lm - 2 Step MacAdam  
 ☐ - 230V/50Hz - CE - ▽ - ⚡ - A  
 Incl. LED driver (phase DIM, 1-10V or DALI)  
 Standard beam angle 36° (options 12°, 24°)  
 h = 150 mm

### INDOX 50 MINI LED 700LM CRI 80

REF N°	2700°K	3000°K	4000°K
phase DIM	221 72 041	221 72 141	221 72 241
DIM 1-10V	221 62 041	221 62 141	221 62 241
DIM DALI	221 32 041	221 32 141	221 32 241

Xicato LED - 5,6 W - 720lm - 2 Step MacAdam  
 ☐ - 230V/50Hz - CE - ▽ - ⚡ - A+  
 Incl. LED driver (phase DIM, 1-10V or DALI)  
 Standard beam angle 36° (options 12°, 24°)  
 h = 92 mm (phase DIM models beam 36°)  
 h = 115 mm (all other models)

### INDOX 50 MINI LED 700LM CRI 97

REF N°	2700°K	3000°K	4000°K
phase DIM	221 72 941	221 72 841	221 72 741
DIM 1-10V	221 62 941	221 62 841	221 62 741
DIM DALI	221 32 941	221 32 841	221 32 741

Xicato LED - 7,4 W - 720lm - 2 Step MacAdam  
 ☐ - 230V/50Hz - CE - ▽ - ⚡ - A  
 Incl. LED driver (phase DIM, 1-10V or DALI)  
 Standard beam angle 36° (options 12°, 24°)  
 h = 115 mm (models beam angle 36°)  
 h = 150 mm (models beam angle 12° or 24°)

### INDOX 50 MINI HAL

REF N° 221 10 051

☐ QR-CBC 51 - 50W - Gx5.3 - 12V  
 ☐ - CE - ⚡ - ▽ - (0.5m) - D  
 h = 92 mm - exclusive lamp and transfo

### INDOX 50 MINI ES

REF N° 221 11 051

☐ QPAR 16 - 50W - GZ10/GU10 - ⚡  
 ☐ - CE - 230V/50Hz - ▽ - (0.5m) - D  
 h = 93 mm - exclusive lamp



# TECHNICAL DATA SHEET

## INDOX 50 MINI IP54

OUTDOOR - ESTERNO - AUßENBEREICH - EXTERIEUR - EXTÉRIEUR - EXTERIOR

Fix (not adjustable) 0° - 0°

114x144 mm

Material : waterproof CALCYT+®

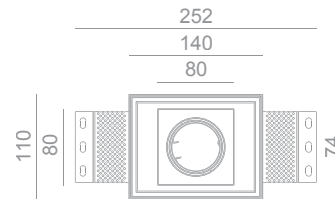
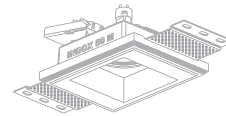

### INSTALLATION KIT

- STANDARD** (included) installation system for ceiling 9 - 12 - 15 mm
- REF N° 221 99 025** installation system for gypsum ceiling 25 mm
- REF N° 221 99 030** installation system for gypsum ceiling 30 mm
- REF N° 834 00 000** Concrete box InDox 50 mini - Galvanized steel

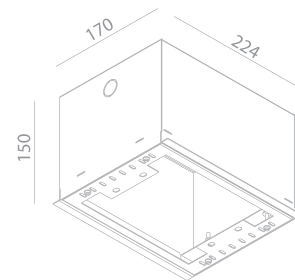

### BEAM ANGLES

- STANDARD** (included) beam angle 36°
- REF N° 205 50 012** optional beam angle 12°
- REF N° 205 50 024** optional beam angle 24°

### EMERGENCY UNITS

- REF N° 693 01 001** 1h basic + control LED
- REF N° 693 01 003** 3h basic + control LED
- REF N° 693 30 001** 1h EMPRO DALI
- REF N° 693 30 003** 3h EMPRO DALI

**INDOX 50 MINI LED WARM DIM**

**WARM DIM : DIMS FROM 3000°K TO 2000°K**

REF N°	500LM CRI80	900LM CRI90
phase DIM	221 72 645	221 73 645
DIM 1-10V	221 62 645	221 63 645
DIM DALI	221 32 645	221 33 645

6W (500lm) - 12,8W (900lm) - 4 Step MacAdam  
 ☐ - 230V/50Hz - CE - ▽ - ⚡ - B  
 Incl. LED driver (phase DIM, 1-10V or DALI)  
 Standard beam angle 36° (options 24°)  
 h = 115 mm (500lm) - h = 150 mm (900lm)

**INDOX 50 MINI LED 1300LM CRI 80**

REF N°	2700°K	3000°K	4000°K
phase DIM	221 73 045	221 73 145	221 73 245
DIM 1-10V	221 63 045	221 63 145	221 63 245
DIM DALI	221 33 045	221 33 145	221 33 245

Xicato LED - 11,7W - 1300lm - 2 Step MacAdam  
 ☐ - 230V/50Hz - CE - ▽ - ⚡ - A  
 Incl. LED driver (phase DIM, 1-10V or DALI)  
 Standard beam angle 36° (options 12°, 24°)  
 h = 150 mm

**INDOX 50 MINI LED 700LM CRI 80**

REF N°	2700°K	3000°K	4000°K
phase DIM	221 72 045	221 72 145	221 72 245
DIM 1-10V	221 62 045	221 62 145	221 62 245
DIM DALI	221 32 045	221 32 145	221 32 245

Xicato LED - 5,6 W - 720lm - 2 Step MacAdam  
 ☐ - 230V/50Hz - CE - ▽ - ⚡ - A+  
 Incl. LED driver (phase DIM, 1-10V or DALI)  
 Standard beam angle 36° (options 12°, 24°)  
 h = 92 mm (phase DIM models beam 36°)  
 h = 115 mm (all other models)

**INDOX 50 MINI LED 700LM CRI 97**

REF N°	2700°K	3000°K	4000°K
phase DIM	221 72 945	221 72 845	221 72 745
DIM 1-10V	221 62 945	221 62 845	221 62 745
DIM DALI	221 32 945	221 32 845	221 32 745

Xicato LED - 7,4 W - 720lm - 2 Step MacAdam  
 ☐ - 230V/50Hz - CE - ▽ - ⚡ - A  
 Incl. LED driver (phase DIM, 1-10V or DALI)  
 Standard beam angle 36° (options 12°, 24°)  
 h = 115 mm (models beam angle 36°)  
 h = 150 mm (models beam angle 12° or 24°)

**INDOX 50 MINI HAL**

**REF N° 221 10 055**

☞ QR-CBC 51 - 50W - Gx5.3 - 12V  
 ☐ - CE - ⚡ - ▽ - (0.5m) - D  
 h = 92 mm - exclusive lamp and transfo

**INDOX 50 MINI ES**

**REF N° 221 11 055**

☞ QPAR 16 - 50W - GZ10/GU10 - ⚡  
 ☐ - CE - 230V/50Hz - ▽ - (0.5m) - D  
 h = 93 mm - exclusive lamp

# TECHNICAL DATA SHEET

## INDOX 50 MINI IP20

INDOOR - INTERNO - INNENBEREICH - INTERIEUR - INTÉRIEUR - INTERIOR

Adjustable  $\odot$  0° - 30°

$\square$  114x144 mm

Material : CALCYT® plaster

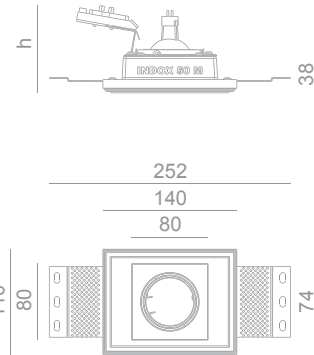
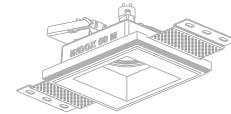

### INSTALLATION KIT

- STANDARD** (included) installation system for ceiling 9 - 12 - 15 mm
- REF N° 221 99 025** installation system for gypsum ceiling 25 mm
- REF N° 221 99 030** installation system for gypsum ceiling 30 mm
- REF N° 834 00 000** Concrete box Indox 50 mini - Galvanized steel

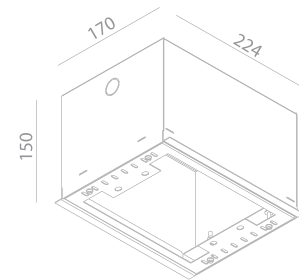

### BEAM ANGLES

- STANDARD** (included) beam angle 36°
- REF N° 205 50 012** optional beam angle 12°
- REF N° 205 50 024** optional beam angle 24°

### EMERGENCY UNITS

- REF N° 693 01 001** 1h basic + control LED
- REF N° 693 01 003** 3h basic + control LED
- REF N° 693 30 001** 1h EMPRO DALI
- REF N° 693 30 003** 3h EMPRO DALI

INDOX 50 MINI LED WARMDIM		
WARMDIM : DIMS FROM 3000°K TO 2000°K		
REF N°	500LM CRI80	900LM CRI90
phase DIM	221 72 640	221 73 640
DIM 1-10V	221 62 640	221 63 640
DIM DALI	221 32 640	221 33 640
6W (500lm) - 12,8W (900lm) - 4 Step MacAdam $\square$ - 230V/50Hz - $\text{CE}$ - $\nabla$ - $\text{A}$ - $\text{B}$ Incl. LED driver (phase DIM, 1-10V or DALI) Standard beam angle 36° (options 24°) h = 115 mm (500lm) - h = 150 mm (900lm)		

INDOX 50 MINI LED 1300LM CRI 80			
REF N°	2700°K	3000°K	4000°K
phase DIM	221 73 040	221 73 140	221 73 240
DIM 1-10V	221 63 040	221 63 140	221 63 240
DIM DALI	221 33 040	221 33 140	221 33 240
Xicato LED - 11,7W - 1300lm - 2 Step MacAdam $\square$ - 230V/50Hz - $\text{CE}$ - $\nabla$ - $\text{A}$ Incl. LED driver (phase DIM, 1-10V or DALI) Standard beam angle 36° (options 12°, 24°) h = 150 mm			

INDOX 50 MINI LED 700LM CRI 80			
REF N°	2700°K	3000°K	4000°K
phase DIM	221 72 040	221 72 140	221 72 240
DIM 1-10V	221 62 040	221 62 140	221 62 240
DIM DALI	221 32 040	221 32 140	221 32 240
Xicato LED - 5,6 W - 720lm - 2 Step MacAdam $\square$ - 230V/50Hz - $\text{CE}$ - $\nabla$ - $\text{A}^+$ Incl. LED driver (phase DIM, 1-10V or DALI) Standard beam angle 36° (options 12°, 24°) h = 92 mm (phase DIM models beam 36°) h = 115 mm (all other models)			

INDOX 50 MINI LED 700LM CRI 97			
REF N°	2700°K	3000°K	4000°K
phase DIM	221 72 940	221 72 840	221 72 740
DIM 1-10V	221 62 940	221 62 840	221 62 740
DIM DALI	221 32 940	221 32 840	221 32 740
Xicato LED - 7,4 W - 720lm - 2 Step MacAdam $\square$ - 230V/50Hz - $\text{CE}$ - $\nabla$ - $\text{A}$ Incl. LED driver (phase DIM, 1-10V or DALI) Standard beam angle 36° (options 12°, 24°) h = 115 mm (models beam angle 36°) h = 150 mm (models beam angle 12° or 24°)			

INDOX 50 MINI HAL
REF N° 221 10 050
$\text{QR-CBC}$ 51 - 50W - Gx5.3 - 12V $\text{CE}$ - $\nabla$ - $\text{D}$ - 0.5m - $\text{D}$ h = 92 mm - exclusive lamp and transfo

INDOX 50 MINI ES
REF N° 221 11 050
$\text{QPAR}$ 16 - 50W - GZ10/GU10 - $\text{A}$ $\text{CE}$ - 230V/50Hz - $\nabla$ - $\text{D}$ - 0.5m - $\text{D}$ h = 93 mm - exclusive lamp



# INDOX 50 MINI IP20

ACCESSORIES - ACCESSORI - ZUBEHÖR - ACCESSOIRES - ACCESSOIRES - ACESORIOS



**STANDARD** (included) LAMPHOLDER RING WHITE



**REF N° 201 10 002** LAMPHOLDER RING BLACK



**REF N° 201 11 001**  
EXTENSION S WHITE  
Ø 56 x 26 mm ⊕ 0° - 10°



**REF N° 201 12 001**  
EXTENSION M WHITE  
Ø 56 x 36 mm ⊕ 0° - 10°



**REF N° 201 13 001**  
EXTENSION L WHITE  
Ø 56 x 68 mm ⊕ 0° - 10°



**REF N° 201 11 002**  
EXTENSION S BLACK  
Ø 56 x 26 mm ⊕ 0° - 10°



**REF N° 201 12 002**  
EXTENSION M BLACK  
Ø 56 x 36 mm ⊕ 0° - 10°



**REF N° 201 13 002**  
EXTENSION L BLACK  
Ø 56 x 68 mm ⊕ 0° - 10°



**REF N° 201 51 001**  
FROSTED PLEXI WHITE  
Only for LED lampsources



**REF N° 201 52 001**  
HONEYCOMB WHITE  
Only for LED lampsources



**REF N° 201 53 001**  
SPHERICAL GLASS LENS  
IN WHITE RING



**REF N° 201 51 002**  
FROSTED PLEXI BLACK  
Only for LED lampsources



**REF N° 201 52 002**  
HONEYCOMB BLACK  
Only for LED lampsources



**REF N° 201 53 002**  
SPHERICAL GLASS LENS  
IN BLACK RING

# TECHNICAL DATA SHEET

## INDOX 3X50 IP54

BATHROOM - STANZA DA BAGNO - BADEZIMMER - BADKAMER - SALLE DE BAINS - CUARTO DE BAÑO

Fix (not adjustable) 0° - 0°

168x359 mm

Material : CALCYT® plaster

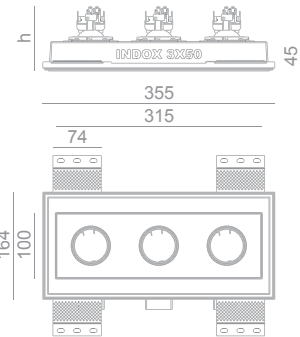
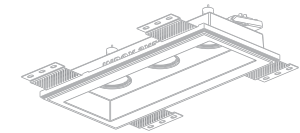

**INDOX 3X50 LED WARMDIM**

**WARMDIM : DIMS FROM 3000°K TO 2000°K**

REF N°	500LM CRI80
phaseDIM	223 72 641
DIM 1-10V	223 62 641
DIM DALI	223 32 641

3x 6 W - 3x 500lm - 4 Step MacAdam  
 ☐ - 230V/50Hz - CE - ▽ - ⚡ - B  
 Incl. LED driver (phase DIM, 1-10V or DALI)  
 Standard beam angle 36° (options 24°)  
 h = 120 mm

**INDOX 3X50 LED 1300LM CRI 80**

REF N°	2700°K	3000°K	4000°K
phase DIM	223 73 041	223 73 141	223 73 241
DIM 1-10V	223 63 041	223 63 141	223 63 241
DIM DALI	223 33 041	223 33 141	223 33 241

3x Xicato LED - 3x 11,7 W - 3x 1300lm  
 ☐ - 230V/50Hz - CE - ▽ - ⚡ - A  
 Incl. LED driver (phase DIM, 1-10V or DALI)  
 Standard beam angle 36° (options 12°, 24°)  
 h = 155 mm

**INDOX 3X50 LED 700LM CRI 80**

REF N°	2700°K	3000°K	4000°K
phase DIM	223 72 041	223 72 141	223 72 241
DIM 1-10V	223 62 041	223 62 141	223 62 241
DIM DALI	223 32 041	223 32 141	223 32 241

3x Xicato LED - 3x 5,6 W - 3x 720lm  
 ☐ - 230V/50Hz - CE - ▽ - ⚡ - A+  
 Incl. LED driver (phase DIM, 1-10V or DALI)  
 Standard beam angle 36° (options 12°, 24°)  
 h = 98 mm (phase DIM models beam 36°)  
 h = 120 mm (all other models)

**INDOX 3X50 LED 700LM CRI 97**

REF N°	2700°K	3000°K	4000°K
phase DIM	223 72 941	223 72 841	223 72 741
DIM 1-10V	223 62 941	223 62 841	223 62 741
DIM DALI	223 32 941	223 32 841	223 32 741

3x Xicato LED - 3x 7,4 W - 3x 720lm  
 ☐ - 230V/50Hz - CE - ▽ - ⚡ - A  
 Incl. LED driver (phase DIM, 1-10V or DALI)  
 Standard beam angle 36° (options 12°, 24°)  
 h = 120 mm (models beam angle 36°)  
 h = 155 mm (models beam angle 12° or 24°)

**INDOX 3X50 HAL**

REF N° 223 10 051

☑ 3x QR-CBC 51 - 50W - Gx5.3 - 12V  
 ☐ - CE - ⚡ - ▽ - (0.5m) - D  
 h = 98 mm - exclusive lamp and transfo

**INDOX 3X50 ES**

REF N° 223 11 051

☑ 3x QPAR 16 - 50W - GZ10/GU10 - ⚡  
 ☐ - CE - 230V/50Hz - ▽ - (0.5m) - D  
 h = 100 mm - exclusive lamp

### INSTALLATION KIT

- STANDARD** (included) installation system for ceiling 9 - 12 - 15 mm
- REF N° 223 99 025 installation system for gypsum ceiling 25 mm
- REF N° 223 99 030 installation system for gypsum ceiling 30 mm
- REF N° 844 00 000 Concrete box Indox 3x50 - Galvanized steel

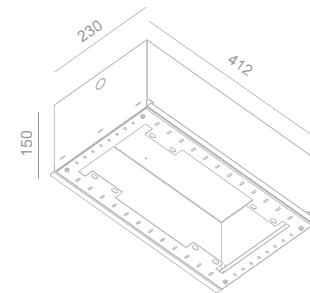

### BEAM ANGLES

- STANDARD** (included) beam angle 36°
- REF N° 205 50 012 optional beam angle 12°
- REF N° 205 50 024 optional beam angle 24°

### EMERGENCY UNITS

- REF N° 693 01 001 1h basic + control LED
- REF N° 693 01 003 3h basic + control LED
- REF N° 693 30 001 1h EMPRO DALI
- REF N° 693 30 003 3h EMPRO DALI



# TECHNICAL DATA SHEET

## INDOX 3X50 IP54

OUTDOOR - ESTERNO - AUßENBEREICH - EXTERIEUR - EXTÉRIEUR - EXTERIOR

Fix (not adjustable) 0° - 0°

168x359 mm

Material : waterproof CALCYT+®

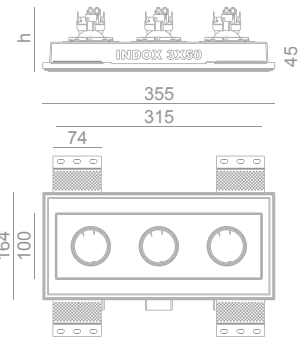
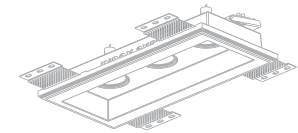

**INDOX 3X50 LED WARMDIM**

**WARMDIM : DIMS FROM 3000°K TO 2000°K**

REF N°	500LM CRI80
phaseDIM	223 72 645
DIM 1-10V	223 62 645
DIM DALI	223 32 645

3x 6 W - 3x 500lm - 4 Step MacAdam  
 ☐ - 230V/50Hz - CE - ▽ - ⚡ - B  
 Incl. LED driver (phase DIM, 1-10V or DALI)  
 Standard beam angle 36° (options 24°)  
 h = 120 mm

**INDOX 3X50 LED 1300LM CRI 80**

REF N°	2700°K	3000°K	4000°K
phase DIM	223 73 045	223 73 145	223 73 245
DIM 1-10V	223 63 045	223 63 145	223 63 245
DIM DALI	223 33 045	223 33 145	223 33 245

3x Xicato LED - 3x 11,7 W - 3x 1300lm  
 ☐ - 230V/50Hz - CE - ▽ - ⚡ - A  
 Incl. LED driver (phase DIM, 1-10V or DALI)  
 Standard beam angle 36° (options 12°, 24°)  
 h = 155 mm

**INDOX 3X50 LED 700LM CRI 80**

REF N°	2700°K	3000°K	4000°K
phase DIM	223 72 045	223 72 145	223 72 245
DIM 1-10V	223 62 045	223 62 145	223 62 245
DIM DALI	223 32 045	223 32 145	223 32 245

3x Xicato LED - 3x 5,6 W - 3x 720lm  
 ☐ - 230V/50Hz - CE - ▽ - ⚡ - A+  
 Incl. LED driver (phase DIM, 1-10V or DALI)  
 Standard beam angle 36° (options 12°, 24°)  
 h = 98 mm (phase DIM models beam 36°)  
 h = 120 mm (all other models)

**INDOX 3X50 LED 700LM CRI 97**

REF N°	2700°K	3000°K	4000°K
phase DIM	223 72 945	223 72 845	223 72 745
DIM 1-10V	223 62 945	223 62 845	223 62 745
DIM DALI	223 32 945	223 32 845	223 32 745

3x Xicato LED - 3x 7,4 W - 3x 720lm  
 ☐ - 230V/50Hz - CE - ▽ - ⚡ - A  
 Incl. LED driver (phase DIM, 1-10V or DALI)  
 Standard beam angle 36° (options 12°, 24°)  
 h = 120 mm (models beam angle 36°)  
 h = 155 mm (models beam angle 12° or 24°)

**INDOX 3X50 HAL**

**REF N° 223 10 055**

☑ 3x QR-CBC 51 - 50W - Gx5.3 - 12V  
 ☐ - CE - ⚡ - ▽ - (0.5m) - D  
 h = 98 mm - exclusive lamp and transfo

**INDOX 3X50 ES**

**REF N° 223 11 055**

☑ 3x QPAR 16 - 50W - GZ10/GU10 - ⚡  
 ☐ - CE - 230V/50Hz - ▽ - (0.5m) - D  
 h = 100 mm - exclusive lamp

### INSTALLATION KIT

- STANDARD** (included) installation system for ceiling 9 - 12 - 15 mm
- REF N° 223 99 025** installation system for gypsum ceiling 25 mm
- REF N° 223 99 030** installation system for gypsum ceiling 30 mm
- REF N° 844 00 000** Concrete box Indox 3x50 - Galvanized steel

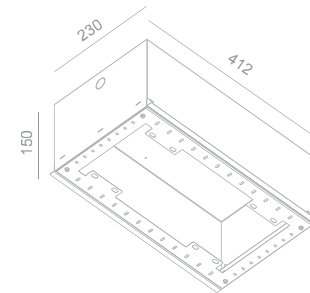

### BEAM ANGLES

- STANDARD** (included) beam angle 36°
- REF N° 205 50 012** optional beam angle 12°
- REF N° 205 50 024** optional beam angle 24°

### EMERGENCY UNITS

- REF N° 693 01 001** 1h basic + control LED
- REF N° 693 01 003** 3h basic + control LED
- REF N° 693 30 001** 1h EMPRO DALI
- REF N° 693 30 003** 3h EMPRO DALI

# TECHNICAL DATA SHEET

## INDOX 3X50 IP20

INDOOR - INTERNO - INNENBEREICH - INTERIEUR - INTÉRIEUR - INTERIOR

Adjustable  $\odot$  0° - 30°

$\square$  168x359 mm

Material : CALCYT® plaster

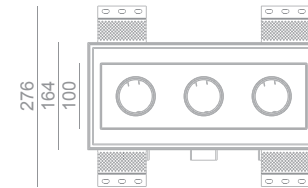
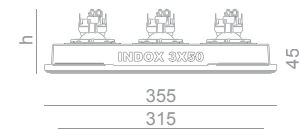
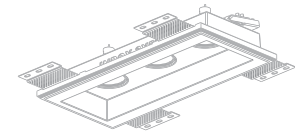

INDOX 3X50 LED WARMDIM	
WARMDIM : DIMS FROM 3000°K TO 2000°K	
REF N°	500LM CRI80
phase DIM	223 72 640
DIM 1-10V	223 62 640
DIM DALI	223 32 640
3x 6 W - 3x 500lm - 4 Step MacAdam $\square$ - 230V/50Hz - $\text{CE}$ - $\nabla$ - $\text{A}$ - $\text{B}$ Incl. LED driver (phase DIM, 1-10V or DALI) Standard beam angle 36° (options 24°) h = 120 mm	

INDOX 3X50 LED 1300LM CRI 80			
REF N°	2700°K	3000°K	4000°K
phase DIM	223 73 040	223 73 140	223 73 240
DIM 1-10V	223 63 040	223 63 140	223 63 240
DIM DALI	223 33 040	223 33 140	223 33 240
3x Xicato LED - 3x 11,7 W - 3x 1300lm $\square$ - 230V/50Hz - $\text{CE}$ - $\nabla$ - $\text{A}$ Incl. LED driver (phase DIM, 1-10V or DALI) Standard beam angle 36° (options 12°, 24°) h = 155 mm			

INDOX 3X50 LED 700LM CRI 80			
REF N°	2700°K	3000°K	4000°K
phase DIM	223 72 040	223 72 140	223 72 240
DIM 1-10V	223 62 040	223 62 140	223 62 240
DIM DALI	223 32 040	223 32 140	223 32 240
3x Xicato LED - 3x 5,6 W - 3x 720lm $\square$ - 230V/50Hz - $\text{CE}$ - $\nabla$ - $\text{A}^+$ Incl. LED driver (phase DIM, 1-10V or DALI) Standard beam angle 36° (options 12°, 24°) h = 98 mm (phase DIM models beam 36°) h = 120 mm (all other models)			

INDOX 3X50 LED 700LM CRI 97			
REF N°	2700°K	3000°K	4000°K
phase DIM	223 72 940	223 72 840	223 72 740
DIM 1-10V	223 62 940	223 62 840	223 62 740
DIM DALI	223 32 940	223 32 840	223 32 740
3x Xicato LED - 3x 7,4 W - 3x 720lm $\square$ - 230V/50Hz - $\text{CE}$ - $\nabla$ - $\text{A}$ Incl. LED driver (phase DIM, 1-10V or DALI) Standard beam angle 36° (options 12°, 24°) h = 120 mm (models beam angle 36°) h = 155 mm (models beam angle 12° or 24°)			

INDOX 3X50 HAL	
REF N° 223 10 050	
$\text{E}$ 3x QR-CBC 51 - 50W - Gx5.3 - 12V $\text{E}$ - $\text{CE}$ - $\text{A}$ - $\nabla$ - $\text{D}$ h = 98 mm - exclusive lamp and transfo	

INDOX 3X50 ES	
REF N° 223 11 050	
$\text{E}$ 3x QPAR 16 - 50W - GZ10/GU10 - $\text{A}$ $\text{E}$ - $\text{CE}$ - 230V/50Hz - $\nabla$ - $\text{D}$ h = 100 mm - exclusive lamp	

### INSTALLATION KIT

- STANDARD** (included) installation system for ceiling 9 - 12 - 15 mm
- REF N° 223 99 025** installation system for gypsum ceiling 25 mm
- REF N° 223 99 030** installation system for gypsum ceiling 30 mm
- REF N° 844 00 000** Concrete box Indox 3x50 - Galvanized steel

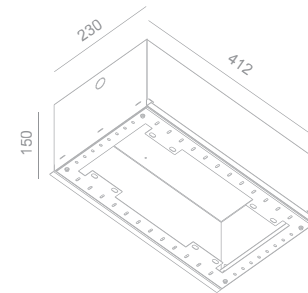

### BEAM ANGLES

- STANDARD** (included) beam angle 36°
- REF N° 205 50 012** optional beam angle 12°
- REF N° 205 50 024** optional beam angle 24°

### EMERGENCY UNITS

- REF N° 693 01 001** 1h basic + control LED
- REF N° 693 01 003** 3h basic + control LED
- REF N° 693 30 001** 1h EMPRO DALI
- REF N° 693 30 003** 3h EMPRO DALI

# INDOX 3X50 IP20

ACCESSORIES - ACCESSORI - ZUBEHÖR - ACCESSOIRES - ACCESORIOS



**STANDARD** (included) 3 x LAMPHOLDER RING WHITE



**REF N° 201 10 032** 3 x LAMPHOLDER RING BLACK



**REF N° 201 11 001**

1 x EXTENSION S WHITE  
Ø 56 x 26 mm ⌀ 0° - 10°



**REF N° 201 12 001**

1 x EXTENSION M WHITE  
Ø 56 x 36 mm ⌀ 0° - 10°



**REF N° 201 13 001**

1 x EXTENSION L WHITE  
Ø 56 x 68 mm ⌀ 0° - 10°



**REF N° 201 11 002**

1 x EXTENSION S BLACK  
Ø 56 x 26 mm ⌀ 0° - 10°



**REF N° 201 12 002**

1 x EXTENSION M BLACK  
Ø 56 x 36 mm ⌀ 0° - 10°



**REF N° 201 13 002**

1 x EXTENSION L BLACK  
Ø 56 x 68 mm ⌀ 0° - 10°



**REF N° 201 51 001**

1 x FROSTED PLEXI WHITE  
Only for LED lampsources



**REF N° 201 52 001**

1 x HONEYCOMB WHITE  
Only for LED lampsources



**REF N° 201 53 001**

1 x SPHERICAL GLASS LENS  
IN WHITE RING



**REF N° 201 51 002**

1 x FROSTED PLEXI BLACK  
Only for LED lampsources



**REF N° 201 52 002**

1 x HONEYCOMB BLACK  
Only for LED lampsources



**REF N° 201 53 002**

1 x SPHERICAL GLASS LENS  
IN BLACK RING



# TECHNICAL DATA SHEET

## INDOX 2X50 IP54

BATHROOM - STANZA DA BAGNO - BADEZIMMER - BADKAMER - SALLE DE BAINS - CUARTO DE BAÑO

Fix (not adjustable) 0° - 0°

144x283 mm

Material : CALCYT® plaster

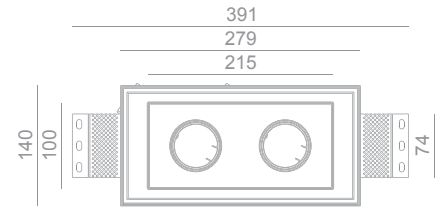
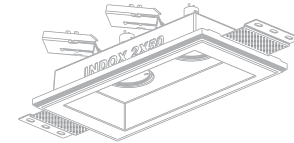

INDOX 2X50 LED WARMDIM	
WARMDIM : DIMS FROM 3000°K TO 2000°K	
REF N°	500LM CRI80
phase DIM	229 72 641
DIM 1-10V	229 62 641
DIM DALI	229 32 641
2x 6 W - 2x 500lm - 4 Step MacAdam	
☐ - 230V/50Hz - CE - ▽ - ⚡ - B	
Incl. LED driver (phase DIM, 1-10V or DALI)	
Standard beam angle 36° (options 24°)	
h = 120 mm	

INDOX 2X50 LED 1300LM CRI 80			
REF N°	2700°K	3000°K	4000°K
phase DIM	229 73 041	229 73 141	229 73 241
DIM 1-10V	229 63 041	229 63 141	229 63 241
DIM DALI	229 33 041	229 33 141	229 33 241
2x Xicato LED - 2x 11,7 W - 2x 1300lm			
☐ - 230V/50Hz - CE - ▽ - ⚡ - A			
Incl. LED driver (phase DIM, 1-10V or DALI)			
Standard beam angle 36° (options 12°, 24°)			
h = 155 mm			

INDOX 2X50 LED 700LM CRI 80			
REF N°	2700°K	3000°K	4000°K
phase DIM	229 72 041	229 72 141	229 72 241
DIM 1-10V	229 62 041	229 62 141	229 62 241
DIM DALI	229 32 041	229 32 141	229 32 241
2x Xicato LED - 2x 5,6 W - 2x 720lm			
☐ - 230V/50Hz - CE - ▽ - ⚡ - A+			
Incl. LED driver (phase DIM, 1-10V or DALI)			
Standard beam angle 36° (options 12°, 24°)			
h = 98 mm (phase DIM models beam 36°)			
h = 120 mm (all other models)			

INDOX 2X50 LED 700LM CRI 97			
REF N°	2700°K	3000°K	4000°K
phase DIM	229 72 941	229 72 841	229 72 741
DIM 1-10V	229 62 941	229 62 841	229 62 741
DIM DALI	229 32 941	229 32 841	229 32 741
2x Xicato LED - 2x 7,4 W - 2x 720lm			
☐ - 230V/50Hz - CE - ▽ - ⚡ - A			
Incl. LED driver (phase DIM, 1-10V or DALI)			
Standard beam angle 36° (options 12°, 24°)			
h = 120 mm (models beam angle 36°)			
h = 155 mm (models beam angle 12° or 24°)			

INDOX 2X50 HAL	
REF N° 229 10 051	
☑ 2x QR-CBC 51 - 50W - Gx5.3 - 12V	
◊ - CE - ⚡ - ▽ - (0.5m) - D	
h = 98 mm - exclusive lamp and transfo	

INDOX 2X50 ES	
REF N° 229 11 051	
☑ 2x QPAR 16 - 50W - GZ10/GU10 - ⚡	
◊ - CE - 230V/50Hz - ▽ - (0.5m) - D	
h = 100 mm - exclusive lamp	

### INSTALLATION KIT

- STANDARD** (included) installation system for ceiling 9 - 12 - 15 mm
- REF N° 229 99 025** installation system for gypsum ceiling 25 mm
- REF N° 229 99 030** installation system for gypsum ceiling 30 mm
- REF N° 829 00 000** Concrete box InDOX 2x50 - Galvanized steel

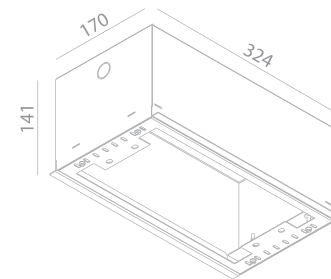

### BEAM ANGLES

- STANDARD** (included) beam angle 36°
- REF N° 205 50 012** optional beam angle 12°
- REF N° 205 50 024** optional beam angle 24°

### EMERGENCY UNITS

- REF N° 693 01 001** 1h basic + control LED
- REF N° 693 01 003** 3h basic + control LED
- REF N° 693 30 001** 1h EMPRO DALI
- REF N° 693 30 003** 3h EMPRO DALI



# TECHNICAL DATA SHEET

## INDOX 2X50 IP54

OUTDOOR - ESTERNO - AUßENBEREICH - EXTERIEUR - EXTÉRIEUR - EXTERIOR

Fix (not adjustable) 0° - 0°

144x283 mm

Material : waterproof CALCYT+®

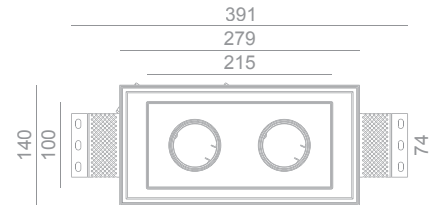
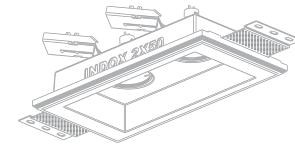

INDOX 2X50 LED WARMDIM	
WARMDIM : DIMS FROM 3000°K TO 2000°K	
REF N°	500LM CRI80
phase DIM	229 72 645
DIM 1-10V	229 62 645
DIM DALI	229 32 645
2x 6 W - 2x 500lm - 4 Step MacAdam	
☐ - 230V/50Hz - CE - ▽ - ⚡ - B	
Incl. LED driver (phase DIM, 1-10V or DALI)	
Standard beam angle 36° (options 24°)	
h = 120 mm	

INDOX 2X50 LED				
1300LM CRI 80				
REF N°	2700°K	3000°K	4000°K	
phase DIM	229 73 045	229 73 145	229 73 245	
DIM 1-10V	229 63 045	229 63 145	229 63 245	
DIM DALI	229 33 045	229 33 145	229 33 245	
2x Xicato LED - 2x 11,7 W - 2x 1300lm				
☐ - 230V/50Hz - CE - ▽ - ⚡ - A				
Incl. LED driver (phase DIM, 1-10V or DALI)				
Standard beam angle 36° (options 12°, 24°)				
h = 155 mm				

INDOX 2X50 LED				
700LM CRI 80				
REF N°	2700°K	3000°K	4000°K	
phase DIM	229 72 045	229 72 145	229 72 245	
DIM 1-10V	229 62 045	229 62 145	229 62 245	
DIM DALI	229 32 045	229 32 145	229 32 245	
2x Xicato LED - 2x 5,6 W - 2x 720lm				
☐ - 230V/50Hz - CE - ▽ - ⚡ - A+				
Incl. LED driver (phase DIM, 1-10V or DALI)				
Standard beam angle 36° (options 12°, 24°)				
h = 98 mm (phase DIM models beam 36°)				
h = 120 mm (all other models)				

INDOX 2X50 LED				
700LM CRI 97				
REF N°	2700°K	3000°K	4000°K	
phase DIM	229 72 945	229 72 845	229 72 745	
DIM 1-10V	229 62 945	229 62 845	229 62 745	
DIM DALI	229 32 945	229 32 845	229 32 745	
2x Xicato LED - 2x 7,4 W - 2x 720lm				
☐ - 230V/50Hz - CE - ▽ - ⚡ - A				
Incl. LED driver (phase DIM, 1-10V or DALI)				
Standard beam angle 36° (options 12°, 24°)				
h = 120 mm (models beam angle 36°)				
h = 155 mm (models beam angle 12° or 24°)				

INDOX 2X50 HAL	
REF N° 229 10 055	
☑ 2x QR-CBC 51 - 50W - Gx5.3 - 12V	
◊ - CE - ⚡ - ▽ - (0.5m) - D	
h = 98 mm - exclusive lamp and transfo	

INDOX 2X50 ES	
REF N° 229 11 055	
☑ 2x QPAR 16 - 50W - GZ10/GU10 - ⚡	
◊ - CE - 230V/50Hz - ▽ - (0.5m) - D	
h = 100 mm - exclusive lamp	

### INSTALLATION KIT

- STANDARD** (included) installation system for ceiling 9 - 12 - 15 mm
- REF N° 229 99 025** installation system for gypsum ceiling 25 mm
- REF N° 229 99 030** installation system for gypsum ceiling 30 mm
- REF N° 829 00 000** Concrete box InDOX 2x50 - Galvanized steel

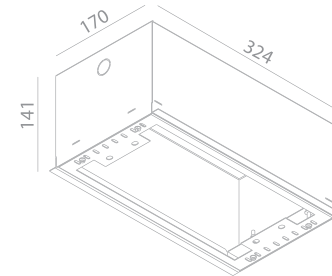

### BEAM ANGLES

- STANDARD** (included) beam angle 36°
- REF N° 205 50 012** optional beam angle 12°
- REF N° 205 50 024** optional beam angle 24°

### EMERGENCY UNITS

- REF N° 693 01 001** 1h basic + control LED
- REF N° 693 01 003** 3h basic + control LED
- REF N° 693 30 001** 1h EMPRO DALI
- REF N° 693 30 003** 3h EMPRO DALI

# TECHNICAL DATA SHEET

## INDOX 2X50 IP20

INDOOR - INTERNO - INNENBEREICH - INTERIEUR - INTÉRIEUR - INTERIOR

Adjustable  $\phi$  0° - 30°

□ 144x283 mm

Material : CALCYT® plaster

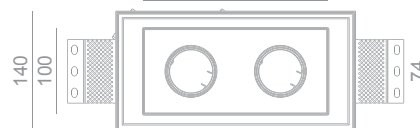
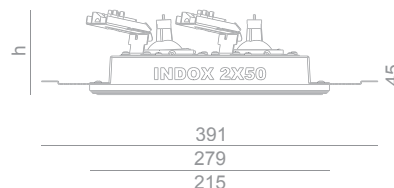
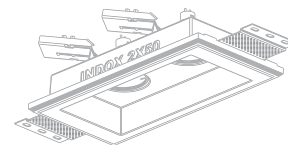

INDOX 2X50 LED WARMDIM	
WARMDIM : DIMS FROM 3000°K TO 2000°K	
REF N°	500LM CRI80
phase DIM	229 72 640
DIM 1-10V	229 62 640
DIM DALI	229 32 640
2x 6 W - 2x 500lm - 4 Step MacAdam	
□ - 230V/50Hz -  -  -  -	
Incl. LED driver (phase DIM, 1-10V or DALI)	
Standard beam angle 36° (options 24°)	
h = 120 mm	

INDOX 2X50 LED 1300LM CRI 80			
REF N°	2700°K	3000°K	4000°K
phase DIM	229 73 040	229 73 140	229 73 240
DIM 1-10V	229 63 040	229 63 140	229 63 240
DIM DALI	229 33 040	229 33 140	229 33 240
2x Xicato LED - 2x 11,7 W - 2x 1300lm			
□ - 230V/50Hz -  -  -  -			
Incl. LED driver (phase DIM, 1-10V or DALI)			
Standard beam angle 36° (options 12°, 24°)			
h = 155 mm			

INDOX 2X50 LED 700LM CRI 80			
REF N°	2700°K	3000°K	4000°K
phase DIM	229 72 040	229 72 140	229 72 240
DIM 1-10V	229 62 040	229 62 140	229 62 240
DIM DALI	229 32 040	229 32 140	229 32 240
2x Xicato LED - 2x 5,6 W - 2x 720lm			
□ - 230V/50Hz -  -  -  -			
Incl. LED driver (phase DIM, 1-10V or DALI)			
Standard beam angle 36° (options 12°, 24°)			
h = 98 mm (phase DIM models beam 36°)			
h = 120 mm (all other models)			

INDOX 2X50 LED 700LM CRI 97			
REF N°	2700°K	3000°K	4000°K
phase DIM	229 72 940	229 72 840	229 72 740
DIM 1-10V	229 62 940	229 62 840	229 62 740
DIM DALI	229 32 940	229 32 840	229 32 740
2x Xicato LED - 2x 7,4 W - 2x 720lm			
□ - 230V/50Hz -  -  -  -			
Incl. LED driver (phase DIM, 1-10V or DALI)			
Standard beam angle 36° (options 12°, 24°)			
h = 120 mm (models beam angle 36°)			
h = 155 mm (models beam angle 12° or 24°)			

INDOX 2X50 HAL	
REF N° 229 10 050	
☞ 2x QR-CBC 51 - 50W - Gx5.3 - 12V	
◊ -  -  -  -  -	
h = 98 mm - exclusive lamp and transfo	

INDOX 2X50 ES	
REF N° 229 11 050	
☞ 2x QPAR 16 - 50W - GZ10/GU10 -	
◊ -  - 230V/50Hz -  -  -  -	
h = 100 mm - exclusive lamp	

### INSTALLATION KIT

- STANDARD** (included) installation system for ceiling 9 - 12 - 15 mm
- REF N° 229 99 025** installation system for gypsum ceiling 25 mm
- REF N° 229 99 030** installation system for gypsum ceiling 30 mm
- REF N° 829 00 000** Concrete box InDOX 2x50 - Galvanized steel

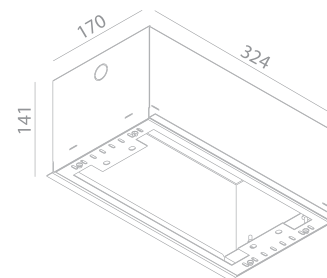

### BEAM ANGLES

- STANDARD** (included) beam angle 36°
- REF N° 205 50 012** optional beam angle 12°
- REF N° 205 50 024** optional beam angle 24°

### EMERGENCY UNITS

- REF N° 693 01 001** 1h basic + control LED
- REF N° 693 01 003** 3h basic + control LED
- REF N° 693 30 001** 1h EMPRO DALI
- REF N° 693 30 003** 3h EMPRO DALI

# INDOX 2X50 IP20

ACCESSORIES - ACCESSORI - ZUBEHÖR - ACCESSOIRES - ACCESORIOS



**STANDARD** (included) 2 x LAMPHOLDER RING WHITE



**REF N° 201 10 022** 2 x LAMPHOLDER RING BLACK



**REF N° 201 11 001**  
1 x EXTENSION S WHITE  
Ø 56 x 26 mm ⌀ 0° - 10°



**REF N° 201 12 001**  
1 x EXTENSION M WHITE  
Ø 56 x 36 mm ⌀ 0° - 10°



**REF N° 201 13 001**  
1 x EXTENSION L WHITE  
Ø 56 x 68 mm ⌀ 0° - 10°



**REF N° 201 11 002**  
1 x EXTENSION S BLACK  
Ø 56 x 26 mm ⌀ 0° - 10°



**REF N° 201 12 002**  
1 x EXTENSION M BLACK  
Ø 56 x 36 mm ⌀ 0° - 10°



**REF N° 201 13 002**  
1 x EXTENSION L BLACK  
Ø 56 x 68 mm ⌀ 0° - 10°



**REF N° 201 51 001**  
1 x FROSTED PLEXI WHITE  
Only for LED lampsources



**REF N° 201 52 001**  
1 x HONEYCOMB WHITE  
Only for LED lampsources



**REF N° 201 53 001**  
1 x SPHERICAL GLASS LENS  
IN WHITE RING



**REF N° 201 51 002**  
1 x FROSTED PLEXI BLACK  
Only for LED lampsources



**REF N° 201 52 002**  
1 x HONEYCOMB BLACK  
Only for LED lampsources



**REF N° 201 53 002**  
1 x SPHERICAL GLASS LENS  
IN BLACK RING

# TECHNICAL DATA SHEET

## INDOX 2X50 MINI IP54

BATHROOM - STANZA DA BAGNO - BADEZIMMER - BADKAMER - SALLE DE BAINS - CUARTO DE BAÑO

Fix (not adjustable) 0° - 0°

114x244 mm

Material : CALCYT® plaster

INDOX 2X50 MINI LED WARMDIM	
WARMDIM : DIMS FROM 3000°K TO 2000°K	
REF N°	500LM CRI80
phase DIM	224 72 641
DIM 1-10V	224 62 641
DIM DALI	224 32 641
2x 6 W - 2x 500lm - 4 Step MacAdam	
☐ - 230V/50Hz - CE - ▽ - ⚡ - B	
Incl. LED driver (phase DIM, 1-10V or DALI)	
Standard beam angle 36° (options 24°)	
h = 115 mm	

INDOX 2X50 MINI LED 1300LM CRI 80			
REF N°	2700°K	3000°K	4000°K
phase DIM	224 73 041	224 73 141	224 73 241
DIM 1-10V	224 63 041	224 63 141	224 63 241
DIM DALI	224 33 041	224 33 141	224 33 241
2x Xicato LED - 2x 11,7 W - 2x 1300lm			
☐ - 230V/50Hz - CE - ▽ - ⚡ - A			
Incl. LED driver (phase DIM, 1-10V or DALI)			
Standard beam angle 36° (options 12°, 24°)			
h = 150 mm			

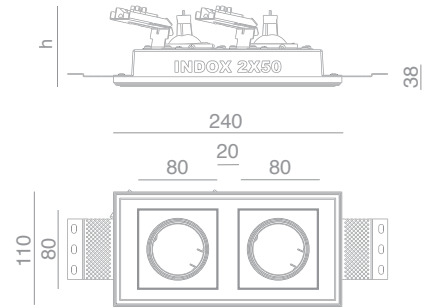

### INSTALLATION KIT

**STANDARD** (included) installation system for ceiling 9 - 12 - 15 mm

**REF N° 224 99 025** installation system for gypsum ceiling 25 mm

**REF N° 224 99 030** installation system for gypsum ceiling 30 mm

INDOX 2X50 MINI LED 700LM CRI 80			
REF N°	2700°K	3000°K	4000°K
phase DIM	224 72 041	224 72 141	224 72 241
DIM 1-10V	224 62 041	224 62 141	224 62 241
DIM DALI	224 32 041	224 32 141	224 32 241
2x Xicato LED - 2x 5,6 W - 2x 720lm			
☐ - 230V/50Hz - CE - ▽ - ⚡ - A+			
Incl. LED driver (phase DIM, 1-10V or DALI)			
Standard beam angle 36° (options 12°, 24°)			
h = 92 mm (phase DIM models beam 36°)			
h = 115 mm (all other models)			

INDOX 2X50 MINI LED 700LM CRI 97			
REF N°	2700°K	3000°K	4000°K
phase DIM	224 72 941	224 72 841	224 72 741
DIM 1-10V	224 62 941	224 62 841	224 62 741
DIM DALI	224 32 941	224 32 841	224 32 741
2x Xicato LED - 2x 7,4 W - 2x 720lm			
☐ - 230V/50Hz - CE - ▽ - ⚡ - A			
Incl. LED driver (phase DIM, 1-10V or DALI)			
Standard beam angle 36° (options 12°, 24°)			
h = 115 mm (models beam angle 36°)			
h = 150 mm (models beam angle 12° or 24°)			

### BEAM ANGLES

**STANDARD** (included) beam angle 36°

**REF N° 205 50 012** optional beam angle 12°

**REF N° 205 50 024** optional beam angle 24°

INDOX 2X50 MINI HAL	
REF N° 224 10 051	
☑ 2x QR-CBC 51 - 50W - Gx5.3 - 12V	
☐ - CE - ⚡ - ▽ - (0.5m) - D	
h = 92 mm - exclusive lamp and transfo	

INDOX 2X50 MINI ES	
REF N° 224 11 051	
☑ 2x QPAR 16 - 50W - GZ10/GU10 - ⚡	
☐ - CE - 230V/50Hz - ▽ - (0.5m) - D	
h = 93 mm - exclusive lamp	

### EMERGENCY UNITS

**REF N° 693 01 001** 1h basic + control LED

**REF N° 693 01 003** 3h basic + control LED

**REF N° 693 30 001** 1h EMPRO DALI

**REF N° 693 30 003** 3h EMPRO DALI





# TECHNICAL DATA SHEET

## INDOX 2X50 MINI IP54

OUTDOOR - ESTERNO - AUßENBEREICH - EXTERIEUR - EXTÉRIEUR - EXTERIOR

Fix (not adjustable) 0° - 0°



114x244 mm

Material : waterproof CALCYT+®

**INDOX 2X50 MINI LED WARM-DIM**



**WARMDIM : DIMS FROM 3000°K TO 2000°K**

REF N°	500LM CRI80
phase DIM	224 72 645
DIM 1-10V	224 62 645
DIM DALI	224 32 645

2x 6 W - 2x 500lm - 4 Step MacAdam  
 - 230V/50Hz -   
 Incl. LED driver (phase DIM, 1-10V or DALI)  
 Standard beam angle 36° (options 24°)  
 h = 115 mm

**INDOX 2X50 MINI LED 1300LM CRI 80**

REF N°	2700°K	3000°K	4000°K
phase DIM	224 73 045	224 73 145	224 73 245
DIM 1-10V	224 63 045	224 63 145	224 63 245
DIM DALI	224 33 045	224 33 145	224 33 245

2x Xicato LED - 2x 11,7 W - 2x 1300lm  
 - 230V/50Hz -   
 Incl. LED driver (phase DIM, 1-10V or DALI)  
 Standard beam angle 36° (options 12°, 24°)  
 h = 150 mm

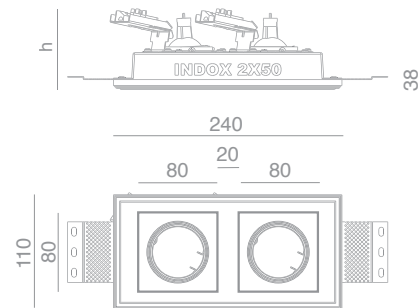



### INSTALLATION KIT

- STANDARD** (included) installation system for ceiling 9 - 12 - 15 mm  
**REF N° 224 99 025** installation system for gypsum ceiling 25 mm  
**REF N° 224 99 030** installation system for gypsum ceiling 30 mm



**INDOX 2X50 MINI LED 700LM CRI 80**

REF N°	2700°K	3000°K	4000°K
phase DIM	224 72 045	224 72 145	224 72 245
DIM 1-10V	224 62 045	224 62 145	224 62 245
DIM DALI	224 32 045	224 32 145	224 32 245

2x Xicato LED - 2x 5,6 W - 2x 720lm  
 - 230V/50Hz -   
 Incl. LED driver (phase DIM, 1-10V or DALI)  
 Standard beam angle 36° (options 12°, 24°)  
 h = 92 mm (phase DIM models beam 36°)  
 h = 115 mm (all other models)

**INDOX 2X50 MINI LED 700LM CRI 97**

REF N°	2700°K	3000°K	4000°K
phase DIM	224 72 945	224 72 845	224 72 745
DIM 1-10V	224 62 945	224 62 845	224 62 745
DIM DALI	224 32 945	224 32 845	224 32 745

2x Xicato LED - 2x 7,4 W - 2x 720lm  
 - 230V/50Hz -   
 Incl. LED driver (phase DIM, 1-10V or DALI)  
 Standard beam angle 36° (options 12°, 24°)  
 h = 115 mm (models beam angle 36°)  
 h = 150 mm (models beam angle 12° or 24°)

### BEAM ANGLES

- STANDARD** (included) beam angle 36°  
**REF N° 205 50 012** optional beam angle 12°  
**REF N° 205 50 024** optional beam angle 24°

### EMERGENCY UNITS

- REF N° 693 01 001** 1h basic + control LED  
**REF N° 693 01 003** 3h basic + control LED  
**REF N° 693 30 001** 1h EMPRO DALI  
**REF N° 693 30 003** 3h EMPRO DALI

**INDOX 2X50 MINI HAL**

**REF N° 224 10 055**

 2x QR-CBC 51 - 50W - Gx5.3 - 12V  
 -  - 0.5m -   
 h = 92 mm - exclusive lamp and transfo

**INDOX 2X50 MINI ES**

**REF N° 224 11 055**

 2x QPAR 16 - 50W - GZ10/GU10 -   
 - 230V/50Hz -  - 0.5m -   
 h = 93 mm - exclusive lamp

# TECHNICAL DATA SHEET

## INDOX 111 IP20

INDOOR - INTERNO - INNENBEREICH - INTERIEUR - INTÉRIEUR - INTERIOR

Adjustable  $\odot$  0° - 30°

$\square$  194x218 mm

Material : CALCYT® plaster

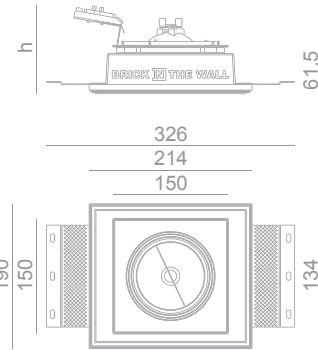

### INSTALLATION KIT

- STANDARD** (included) installation system for ceiling 9 - 12 - 15 mm
- REF N° 231 99 025** installation system for gypsum ceiling 25 mm
- REF N° 231 99 030** installation system for gypsum ceiling 30 mm
- REF N° 831 00 000** Concrete box Indox 111 - Galvanized steel

INDOX 111 LED 3000LM CRI 80			
REF N°	2700°K	3000°K	4000°K
on/off	231 26 040	231 26 140	231 26 240
phase DIM	231 75 040	231 75 140	231 75 240
DIM 1-10V	231 66 040	231 66 140	231 66 240
DIM DALI	231 36 040	231 36 140	231 36 240

Xicato LED- 29,3W - 3000lm - 2 Step MacAdam  
 $\square$  - 230V/50Hz -  $\text{CE}$  -  $\nabla$  -  $\text{A}$  -  $\text{A}$   
 Beam angle 36° (option 20°) - Incl LED driver  
 h = 161 mm

INDOX 111 LED 2000LM CRI 80			
REF N°	2700°K	3000°K	4000°K
on/off	231 25 040	231 25 140	231 25 240
phase DIM	231 75 040	231 75 140	231 75 240
DIM 1-10V	231 65 040	231 65 140	231 65 240
DIM DALI	231 35 040	231 35 140	231 35 240

Xicato LED- 19,5W - 2000lm - 2 Step MacAdam  
 $\square$  - 230V/50Hz -  $\text{CE}$  -  $\nabla$  -  $\text{A}$  -  $\text{A}$   
 Beam 36° (option 20°) - Incl LED driver  
 h = 161 mm

INDOX 111 LED 1300LM CRI 97			
REF N°	2700°K	3000°K	4000°K
on/off	231 23 940	231 23 840	231 23 740
phase DIM	231 73 940	231 73 840	231 73 740
DIM 1-10V	231 63 940	231 63 840	231 63 740
DIM DALI	231 33 940	231 33 840	231 33 740

Xicato LED- 17,6W - 1300lm - 2 Step MacAdam  
 $\square$  - 230V/50Hz -  $\text{CE}$  -  $\nabla$  -  $\text{A}$  -  $\text{A}$   
 Beam angle 36° (option 20°) - Incl LED driver  
 h = 161 mm

INDOX 111 LED 2000LM CRI 97			
REF N°	2700°K	3000°K	4000°K
on/off	231 25 940	231 25 840	231 25 740
phase DIM	231 75 940	231 75 840	231 75 740
DIM 1-10V	231 65 940	231 65 840	231 65 740
DIM DALI	231 35 940	231 35 840	231 35 740

Xicato LED- 22,3W - 2000lm - 2 Step MacAdam  
 $\square$  - 230V/50Hz -  $\text{CE}$  -  $\nabla$  -  $\text{A}$  -  $\text{A}$   
 Beam angle 36° (option 20°) - Incl LED driver  
 h = 161 mm

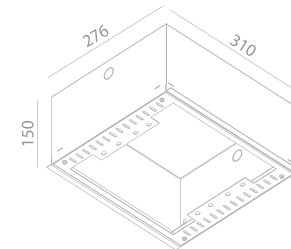

### BEAM ANGLES & OPTIONS

- STANDARD** (included) beam angle 36°
- REF N° 205 11 020** optional beam angle 20°
- REF N° 201 00 060** Frosted diffusor for 111 LED series

### EMERGENCY UNITS

- REF N° 693 01 001** 1h basic + control LED
- REF N° 693 01 003** 3h basic + control LED
- REF N° 693 30 001** 1h EMPRO DALI
- REF N° 693 30 003** 3h EMPRO DALI

INDOX 111 AR	
<b>REF N° 231 13 100</b>	
	QR-LP 111 - 100W - G53 - 12V - $\text{CE}$ - $\text{D}$
excl. transfo - $\text{CE}$ - $\text{D}$ - 1.0m - $\text{CE}$ - $\text{D}$ h = 116 mm	

INDOX 111 CDM	
<b>REF N° 231 19 070</b> CDM-TC - G8.5	
<b>REF N° 231 12 070</b> CDM-R - GX8.5	
35W or 70W - 230V/50Hz - $\text{CE}$ - $\text{B}$ - excl. EVG h = 154 mm - $\text{CE}$ - $\text{B}$	



# TECHNICAL DATA SHEET

## INDOX 2X50 MINI IP20

INDOOR - INTERNO - INNENBEREICH - INTERIEUR - INTÉRIEUR - INTERIOR

Adjustable  $\odot$  0° - 30°

$\square$  114x244 mm

Material : CALCYT® plaster

**INDOX 2X50 MINI LED WARMDIM**

**WARMDIM : DIMS FROM 3000°K TO 2000°K**

REF N°	500LM CRI80
phase DIM	224 72 640
DIM 1-10V	224 62 640
DIM DALI	224 32 640

2x 6 W - 2x 500lm - 4 Step MacAdam  
 $\square$  - 230V/50Hz -  $\text{CE}$  -  $\nabla$  -  $\text{A}$  -  $\text{B}$   
 Incl. LED driver (phase DIM, 1-10V or DALI)  
 Standard beam angle 36° (options 24°)  
 h = 115 mm

**INDOX 2X50 MINI LED 1300LM CRI 80**

REF N°	2700°K	3000°K	4000°K
phase DIM	224 73 040	224 73 140	224 73 240
DIM 1-10V	224 63 040	224 63 140	224 63 240
DIM DALI	224 33 040	224 33 140	224 33 240

2x Xicato LED - 2x 11,7 W - 2x 1300lm  
 $\square$  - 230V/50Hz -  $\text{CE}$  -  $\nabla$  -  $\text{A}$   
 Incl. LED driver (phase DIM, 1-10V or DALI)  
 Standard beam angle 36° (options 12°, 24°)  
 h = 150 mm

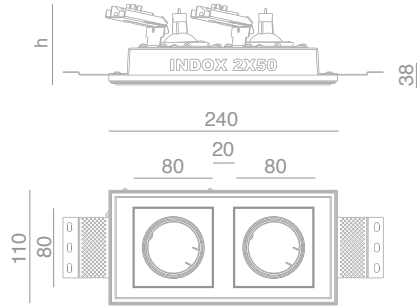

### INSTALLATION KIT

**STANDARD** (included) installation system for ceiling 9 - 12 - 15 mm

**REF N° 224 99 025** installation system for gypsum ceiling 25 mm

**REF N° 224 99 030** installation system for gypsum ceiling 30 mm

**INDOX 2X50 MINI LED 700LM CRI 80**

REF N°	2700°K	3000°K	4000°K
phase DIM	224 72 040	224 72 140	224 72 240
DIM 1-10V	224 62 040	224 62 140	224 62 240
DIM DALI	224 32 040	224 32 140	224 32 240

2x Xicato LED - 2x 5,6 W - 2x 720lm  
 $\square$  - 230V/50Hz -  $\text{CE}$  -  $\nabla$  -  $\text{A}^+$   
 Incl. LED driver (phase DIM, 1-10V or DALI)  
 Standard beam angle 36° (options 12°, 24°)  
 h = 92 mm (phase DIM models beam 36°)  
 h = 115 mm (all other models)

**INDOX 2X50 MINI LED 700LM CRI 97**

REF N°	2700°K	3000°K	4000°K
phase DIM	224 72 940	224 72 840	224 72 740
DIM 1-10V	224 62 940	224 62 840	224 62 740
DIM DALI	224 32 940	224 32 840	224 32 740

2x Xicato LED - 2x 7,4 W - 2x 720lm  
 $\square$  - 230V/50Hz -  $\text{CE}$  -  $\nabla$  -  $\text{A}^+$   
 Incl. LED driver (phase DIM, 1-10V or DALI)  
 Standard beam angle 36° (options 12°, 24°)  
 h = 115 mm (models beam angle 36°)  
 h = 150 mm (models beam angle 12° or 24°)

### BEAM ANGLES

**STANDARD** (included) beam angle 36°

**REF N° 205 50 012** optional beam angle 12°

**REF N° 205 50 024** optional beam angle 24°

### EMERGENCY UNITS

**REF N° 693 01 001** 1h basic + control LED

**REF N° 693 01 003** 3h basic + control LED

**REF N° 693 30 001** 1h EMPRO DALI

**REF N° 693 30 003** 3h EMPRO DALI

**INDOX 2X50 MINI HAL**

**REF N° 224 10 050**

$\text{Q}$  2x QR-CBC 51 - 50W - Gx5.3 - 12V  
 $\text{D}$  -  $\text{CE}$  -  $\text{A}$  -  $\nabla$  -  $\text{D}$  - 0.5m  
 h = 92 mm - exclusive lamp and transfo

**INDOX 2X50 MINI ES**

**REF N° 224 11 050**

$\text{Q}$  2x QPAR 16 - 50W - GZ10/GU10 -  $\text{A}$   
 $\text{D}$  -  $\text{CE}$  - 230V/50Hz -  $\nabla$  -  $\text{D}$  - 0.5m  
 h = 93 mm - exclusive lamp

## INDOX 2X50 MINI IP20

ACCESSORIES - ACCESSORI - ZUBEHÖR - ACCESSOIRES - ACCESORIOS



**STANDARD** (included) 2 x LAMPHOLDER RING WHITE



**REF N° 201 10 022** 2 x LAMPHOLDER RING BLACK



**REF N° 201 11 001**

1 x EXTENSION S WHITE  
Ø 56 x 26 mm ⌀ 0° - 10°



**REF N° 201 12 001**

1 x EXTENSION M WHITE  
Ø 56 x 36 mm ⌀ 0° - 10°



**REF N° 201 13 001**

1 x EXTENSION L WHITE  
Ø 56 x 68 mm ⌀ 0° - 10°



**REF N° 201 11 002**

1 x EXTENSION S BLACK  
Ø 56 x 26 mm ⌀ 0° - 10°



**REF N° 201 12 002**

1 x EXTENSION M BLACK  
Ø 56 x 36 mm ⌀ 0° - 10°



**REF N° 201 13 002**

1 x EXTENSION L BLACK  
Ø 56 x 68 mm ⌀ 0° - 10°



**REF N° 201 51 001**

1 x FROSTED PLEXI WHITE  
Only for LED lampsources



**REF N° 201 52 001**

1 x HONEYCOMB WHITE  
Only for LED lampsources



**REF N° 201 53 001**

1 x SPHERICAL GLASS LENS  
IN WHITE RING



**REF N° 201 51 002**

1 x FROSTED PLEXI BLACK  
Only for LED lampsources



**REF N° 201 52 002**

1 x HONEYCOMB BLACK  
Only for LED lampsources



**REF N° 201 53 002**

1 x SPHERICAL GLASS LENS  
IN BLACK RING



# TECHNICAL DATA SHEET

## INDOX 1434 IP20

INDOOR - INTERNO - INNENBEREICH - INTERIEUR - INTÉRIEUR - INTERIOR

Fix (not adjustable) 0° - 0°

191x474 mm

Material : CALCYT® plaster + frosted diffusor

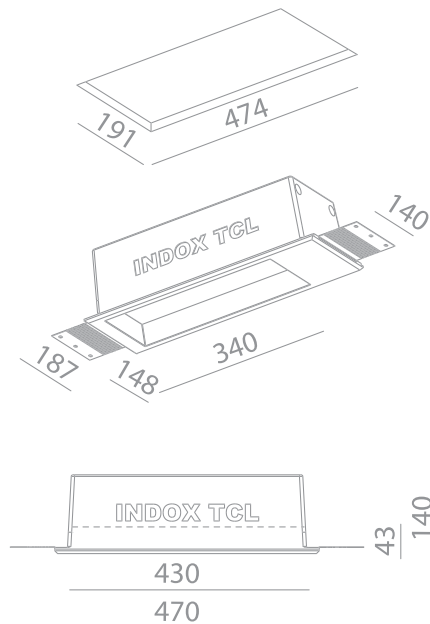

### INDOX 1434 TCL

REF N° 235 22 048

2x TC-L 24W  
2G11 - 230V/50Hz - incl EVG  
191x474 mm - 0.5m - IP40 - 850°C - eco

### INDOX 1434 LED 2500LM

REF N° 235 25 000 on/off 2700K

REF N° 235 25 100 on/off 3000K

REF N° 235 65 000 DIM 1-10V 2700K

REF N° 235 65 100 DIM 1-10V 3000K

REF N° 235 35 000 DIM DALI 2700K

REF N° 235 35 100 DIM DALI 3000K

2550lm@70°C - 32W - 230V/50Hz - incl LED driver  
191x474 mm - 0.5m - IP40 - 850°C - eco

### INSTALLATION KIT

**STANDARD** (included) installation system for ceiling 9 - 12 - 15 mm

**REF N° 235 99 025** installation system for gypsum ceiling 25 mm

**REF N° 235 99 030** installation system for gypsum ceiling 30 mm

**REF N° 835 00 000** Concrete box Indox 1434 - Galvanized steel

